



# QUALICOAT Specifications 2024

Specifications for a quality label for liquid and powder coatings on aluminium for architectural applications

---

Master Version (V01b)

Applicable from 01.01.2024

---

Author: Specifications WG  
Pascale Bellot

Document Code: SPEC 2024

QQM Section: 7.2.6, 7.4.15, 7.8.2, 9.9.2

Date Approved: 15.11.2023

Approved by: Executive Committee

Valid from: 01.01.2024

Version: 01b

No. Pages: 121



# CONTENTS

<b>1</b>	<b>GENERAL INFORMATION .....</b>	<b>6</b>
<b>2</b>	<b>TEST METHODS AND REQUIREMENTS .....</b>	<b>11</b>
2.1	Appearance.....	11
2.2	Gloss .....	11
2.3	Coating thickness .....	12
2.4	Adhesion .....	13
2.4.1	Dry adhesion.....	13
2.4.2	Wet adhesion.....	13
2.5	Buchholz Indentation.....	13
2.6	Cupping test (only for the approval of organic coatings).....	13
2.7	Bend test.....	14
2.8	Impact test .....	15
2.9	Resistance to humid atmospheres containing sulphur dioxide .....	15
2.10	Acetic acid salt spray resistance.....	16
2.11	Machu test.....	16
2.12	Accelerated weathering test .....	17
2.12.1	Accelerated weathering test for classes 1, 1.5 and 2.....	17
2.12.2	Accelerated weathering test for class 3.....	18
2.13	Natural weathering test .....	19
2.14	Polymerisation test .....	20
2.15	Resistance to mortar.....	21
2.16	Constant climate condensation water test.....	21
2.17	Sawing, milling and drilling.....	22
2.18	Filiform corrosion test .....	22
2.19	Water spot test .....	23
2.20	Scratch and mar resistance test (Martindale) .....	23
<b>3</b>	<b>WORK SPECIFICATIONS.....</b>	<b>26</b>
3.1	Storage of the products to be treated and layout of equipment .....	26
3.1.1	Storage .....	26
3.1.2	Layout of equipment .....	26
3.2	Surface preparation .....	26
3.2.1	Etching stage .....	26
3.3	Chemical conversion coatings .....	27
3.3.1	Chromate conversion coatings.....	27
3.3.2	Chemical pretreatments .....	28
3.4	Anodic pretreatment (automatic SEASIDE endorsement).....	29
3.4.1	Requirements for In-house Pre-anodising Process.....	29
3.4.2	Requirements for Treatment and Coating of Pre-anodised Aluminium.....	30
3.5	Electrophoretic coatings .....	32
3.6	Drying .....	32
3.7	Coating and stoving.....	33
3.7.1	Coating .....	33
3.7.2	Stoving.....	33
3.8	Laboratory.....	34
3.9	In-house control .....	34
3.10	Operating Instructions.....	34
3.11	Registers .....	35
<b>4</b>	<b>APPROVAL OF ORGANIC COATINGS .....</b>	<b>37</b>
4.1	Granting of an approval.....	37
4.1.1	Technical information .....	37
4.1.2	Minimum laboratory equipment .....	38



4.1.3	Tests for granting an approval.....	38
4.1.4	Basic colours to be tested for standard approvals and metallic extension.....	39
4.1.5	Basic colours to be tested for special approvals .....	40
4.1.6	Sampling.....	40
4.1.7	Assessment of test results.....	40
4.1.8	Inspection of coating manufacturer's plant.....	41
<b>4.2</b>	<b>Renewal of an approval.....</b>	<b>41</b>
4.2.1	Laboratory tests and Florida exposure.....	41
4.2.1.1	Renewal of class 1 and class 1.5 approvals .....	41
4.2.1.2	Renewal of class 2 and class 3 approvals .....	42
4.2.1.3	Renewal of special approvals.....	42
4.2.2	Sampling.....	42
4.2.3	Assessment of laboratory test results .....	42
4.2.4	Assessment of the Florida test results .....	43
4.2.5	Banned colours.....	43
4.2.6	Suspended colours.....	44
4.2.7	Withdrawal of an approval or extension .....	44
4.2.7.2	Voluntary withdrawal .....	45
4.2.8	Procedure for unbanning colour families for class 2 .....	46
<b>4.3</b>	<b>Powder manufacturer's right of appeal .....</b>	<b>46</b>
<b>4.4</b>	<b>Use of the logo by coating manufacturers .....</b>	<b>46</b>
<b>5</b>	<b>LICENSING OF COATERS' PRODUCTION SITES.....</b>	<b>48</b>
<b>5.1</b>	<b>Granting of a licence (quality label) .....</b>	<b>48</b>
5.1.1	Verification of the data concerning the coating lines .....	49
5.1.2	Inspection of materials.....	49
5.1.3	Inspection of laboratory equipment .....	49
5.1.4	Inspection of production process and equipment.....	49
5.1.5	Inspection of chemical pretreatment.....	49
5.1.6	Inspection of finished products.....	49
5.1.7	Inspection of the test panels.....	50
5.1.8	Review of in-house control and registers .....	50
5.1.9	Final assessment for granting the licence .....	50
5.1.10	'SEASIDE' endorsement .....	51
5.1.11	SEASIDE (PRE-OX) endorsement.....	51
<b>5.2</b>	<b>Routine inspections of licensees .....</b>	<b>51</b>
5.2.1	Verification of the data concerning the coating lines .....	51
5.2.2	Inspectors' equipment and checklists.....	52
5.2.3	Corrosion tests.....	52
5.2.4	Final assessment for renewing the licence .....	53
5.2.5	Licences with SEASIDE endorsement .....	54
5.2.6	Licences with (PRE-OX) endorsement.....	54
5.2.7	Suspension of an inspection.....	54
<b>5.3</b>	<b>Licensee's right of appeal.....</b>	<b>55</b>
<b>5.4</b>	<b>Confidentiality of information .....</b>	<b>55</b>
<b>5.5</b>	<b>Deadlines for submission of inspection reports .....</b>	<b>55</b>
<b>5.6</b>	<b>Use of the logo by licensees.....</b>	<b>55</b>
<b>5.7</b>	<b>Training of licensees.....</b>	<b>55</b>
<b>6</b>	<b>SPECIFICATIONS FOR IN-HOUSE CONTROL .....</b>	<b>57</b>
<b>6.1</b>	<b>Controlling the production process parameters .....</b>	<b>57</b>
6.1.1	Chemical pretreatment baths .....	57
6.1.2	Water quality.....	57
6.1.3	Measuring the temperature of chemical pretreatment and rinsing baths.....	57
6.1.4	Recording and measuring the drying temperature.....	57
6.1.5	Measuring the stoving conditions .....	57
<b>6.2</b>	<b>Quality control of the chemical pretreatment .....</b>	<b>57</b>
6.2.1	Testing the etching degree .....	57



6.2.2 Testing the weight of the conversion coating .....58

**6.3 Quality control of the finished products .....58**

6.3.1 Gloss test (ISO 2813) .....58

6.3.2 Coating thickness test (ISO 2360).....58

6.3.3 Appearance test.....58

6.3.4 Adhesion test.....59

6.3.5 Polymerisation test .....59

6.3.6 Bend test (ISO 1519).....59

6.3.7 Impact test (ISO 6272 / ASTM D 2794).....59

**6.4 Quality control registers .....59**

6.4.1 Control register for the production process .....59

6.4.2 Control register for test panels .....59

6.4.3 Control register for finished products .....60

6.4.4 Control register for tests carried out by the chemical manufacturer.....60

**6.5 Table summarising the specifications for In-House Control.....61**

**APPENDICES .....63**

**A1 – Regulations for use of the QUALICOAT quality label for liquid and powder organic coatings on aluminium for architectural applications.....63**

**A2 – List of currently approved procedures.....68**

**A3 – Compulsory declaration of changes in formulation for organic coating materials approved by QUALICOAT .....69**

**A4 – Metallic organic coating.....71**

**A5 – Special specifications for coatings on aluminium accessories for architectural applications under the QUALICOAT quality label.....73**

**A6 – Approval of chemical pretreatments .....75**

**A6b – Preliminary sampling and testing (PST) of pretreatment-systems with modified processes or new technologies .....83**

**A7 – Specifications for batch treatment.....86**

**A8 – List of colour tolerances before granting or renewing an approval (for QUALICOAT laboratories) .....87**

**A9 – List of relevant standards .....88**

**A10 – Summary of requirements for the approval of organic coating materials (all classes) .....90**

**A11 – RAL families and critical colours .....93**

**A12 – Lists of colour tolerances after weathering tests for granting or renewing an approval .....99**

**A14 – Specifications for Powder coated Material suitable for Postforming .....102**

**A15 – Specifications for off-site anodisers.....117**



# Chapter 1

## General Information



# 1 General Information

## Scope of the Specifications

These Specifications apply to the QUALICOAT quality label, which is a registered trademark. The regulations for use of the quality label are set out in [Appendix A1](#).

QUALICOAT does not allow commercial, financial or other pressures to compromise its impartiality. The Specifications may be amended when risks of impartiality have been identified or when they need to conform to new standards.

The aim of these Specifications is to establish minimum requirements that production sites, coating lines, organic coating materials, chemical conversion materials, processes and finished products shall meet.

These Specifications form the basis for granting and renewing the quality label. All requirements in these Specifications shall be met before a quality label can be granted. In case of ambiguities or uncertainties in any part of the Specifications, clarification shall be requested from QUALICOAT.

The Specifications for production sites and coating lines are the minimum requirements for producing good quality. Other methods may only be used if they have been previously approved by QUALICOAT.

These Specifications are designed to ensure high-quality of coated products for use in architectural applications, whatever kind of coating process is used. Any after-treatment not stipulated in these Specifications may affect the quality of an organic coated product and is the responsibility of whoever applies it.

The procedures for granting and renewing a licence for decoration are set out in a separate document (QUALIDECO Specifications - Appendix to the QUALICOAT Specifications) that can be downloaded from the [QUALICOAT Website](#).

These Specifications apply to material suitable for postforming, but the specific rules, tests, and procedures are detailed only in [Appendix A14 - Specifications for Powder coated Material suitable for Postforming](#). There is no mention of postforming in Chapters 2–6.

## Release and revision of the Specifications

The Specifications may be supplemented or amended with update sheets that set out and incorporate QUALICOAT's resolutions until a new edition is issued. These numbered sheets will state the subject of the resolution, the date when QUALICOAT passed the resolution, the effective date and the details of the resolution. The quality assurance representative in the company holding the label shall always have the latest version of the Specifications.

The Specifications and update sheets are published on the Internet ([www.qualicoat.net](http://www.qualicoat.net)). They shall also be communicated to all licensees and to holders of an approval.

## Aluminium alloy material

The aluminium or aluminium alloy material shall be suitable for the coating processes specified in this document. It shall be free from corrosion and shall not have any anodic or organic coating (except anodic pretreatment as described in these Specifications). It shall also be free from all contaminants, especially silicone lubricants. The edge radii shall be as large as possible.



### QUALICOAT 3.0

To address the problems of corrosion and longevity of coating finishes, QUALICOAT has completed an extensive research programme called 'QUALICOAT 3.0'. The principles of this new quality assessment for the evaluation of the alloying elements, extrusion quality, microstructure, and corrosion potential of both primary and recycled aluminium, are described in a separate document ([Appendix A13 – QUALICOAT 3.0](#)).

### Coating and pretreatment materials

Licensees holding the quality label shall treat all products intended for architectural applications in accordance with these Specifications and shall only use organic coating materials and chemical conversion materials approved by QUALICOAT for such products. For external architectural applications, other materials may be used only at the customer's written request and only if there are technical reasons for doing so. It is not permitted to use unapproved materials for commercial reasons.

### Training

The licensees shall attend training programmes organised regularly by the General Licensee or QUALICOAT.

### Language

The official version of these Specifications are derived from the English language version.

In the English language version, certain verbal forms have meanings which correspond to the requirements of the ISO/IEC Directives, Part 2, Clause 7.

The following verbal forms indicate strict requirements to be followed to comply with these Specifications and from which no deviation is permitted:

- Shall.
- Shall not.

The following verbal forms indicate that among several possibilities, one is recommended as particularly suitable, without mentioning or excluding others, or that a certain course of action is preferred but not necessarily required. Additionally, in the negative form, a certain possibility or course of action is deprecated but not prohibited:

- Should.
- Should not.

The following verbal forms indicate a course of action permissible within the limits of these Specifications:

- May.
- Need not.

The following verbal forms are used for statements of possibility and capability—whether material, physical, or causal:

- Can.
- Cannot.



## Terminology

**Approval:** Confirmation that a specific material (for coating or chemical pretreatment) meets the requirements of the QUALICOAT Specifications.

The following categories of approvals are available:

Classification	Description
P-No.	Approval for powder or liquid coating system
PF-No.	Approval for powder coating system suitable for postforming
A-No.	Approval for chemical pretreatment system (conversion coating) for etched material
AP-No.	Approval for chemical pretreatment system (conversion coating) for pre-anodised material
AN-No.	Approval for chemical pretreatment system (with modified processes or new technologies)

**Coating line:** A production line used for coating aluminium for architectural applications that includes a **single pretreatment cycle** (surface preparation, conversion coating and drying) and a coating cycle (one or more spraying booths and ovens).

**Continuous line:** A production line where parts are pretreated, coated and cured without intermediate handling.

**Curing index:** A numerical index of cure value that quantifies directly from the curing graph the total coating cure experienced against the coating supplier's paint cure schedule

**Licence/Sub-licence:** Permission to use the quality label in accordance with the QUALICOAT Specifications for all coatings on aluminium for architectural applications produced on the coating line(s) at the production site inspected.

**Licensee/Sub-licensee:** The legal entity operating the inspected production site, holding the QUALICOAT licence for this specific production site and acting as this specific licensee on the market. This means marketing all coatings on architectural aluminium produced at this production site using the QUALICOAT label in accordance with the Specifications. The same legal entity may also operate other production sites and hold separate QUALICOAT licences for these.

**General licence:** Permission to grant licences and approvals in a certain territory.

**General Licensee (GL):** National or international association holding the QUALICOAT general licence for a defined territory.

**Material for postforming:** Coated cold-rolled aluminium material suitable for postforming (sheets or coils).





- Postforming:** The act of working, by bending or forming (stamping), already coated aluminium sheets or coils.
- Pretreatment cycle:** A system of tanks for spray or dipping application of chemicals, rinses and/or electrochemical processes, creating a process sequence for pre-treating the workpieces to be coated. A single pretreatment cycle comprises one specific chemical conversion coating step or — in the case of pre-anodising — the pre-anodising bath.
- Production site:** A production facility for coating materials, chemicals, or coatings. In the case of a coating facility, the licensee may operate one or several coating lines in a production site. A production site shall have a distinct postal address.
- Testing laboratories:** Independent quality testing and/or inspection bodies duly authorised by the General Licensee or QUALICOAT.



# Chapter 2

## Test Methods and Requirements

## 2 Test Methods and Requirements

The test methods described below are used to test finished products, organic coating materials and chemical conversion materials for approval (see chapters [4](#) and [5](#)).

The test methods are based on international standards, where they exist, listed in [Appendix A9](#). The requirements are specified by QUALICOAT on the basis of practical experience and/or testing programs organized by QUALICOAT.

For the mechanical tests stipulated in § [2.6](#), § [2.7](#) and § [2.8](#), the test panels shall be made of the alloy AA 5005-H24 or -H14 (AlMg 1 - semihard) with a thickness of 0.8 or 1 mm, unless otherwise approved by QUALICOAT. These mechanical tests shall be carried out on the reverse side of the significant surface.

For the corrosion tests (§ [2.10](#) and § [2.11](#)), the test samples shall be made of AA 6060 or AA 6063. If the main production on a coating line is on sheets or alloys other than AA 6060 or AA 6063, the corrosion tests will be carried out on the material actually used.

### 2.1 Appearance

The appearance will be evaluated on the **significant surface**.

The significant surface shall be defined by the customer and is the part of the total surface which is essential to the appearance and serviceability of the item. Edges, deep recesses and secondary surfaces are not included in the significant surface. The organic coating on the significant surface shall not have any scratches through to the base metal. When the organic coating on the significant surface is viewed at an oblique angle of about 60° to the upper surface, none of the defects listed below shall be visible from a distance of 3 metres: excessive roughness, runs, blisters, inclusions, craters, dull spots, pinholes, pits, scratches or any other unacceptable flaws.

The organic coating shall be of even colour and gloss with good hiding power. When viewed on site, these criteria shall be fulfilled as follows:

- for parts used outside: viewed at a distance of 5 m
- for parts used inside: viewed at a distance of 3 m

#### **Specific requirements for testing and approving coating materials (laboratories):**

The colour of the organic coating shall be measured on the significant surface.

The colour deviation (ISO 11664-4) from the certified RAL card shall not be greater than the limit prescribed in [Appendix A8](#).<sup>1</sup>

### 2.2 Gloss

**ISO 2813** - using incident light at 60° to the normal.

Note: if the significant surface is too small or the finish of the coating (structured finish type a<sup>2</sup>, highly metallic finishes) unsuitable for the gloss to be measured with the glossmeter, the gloss shall be compared visually with the reference sample provided by the powder coating supplier (from the same viewing angle).

---

<sup>1</sup> List of colour tolerances before granting or renewing an approval (for QUALICOAT laboratories)

<sup>2</sup> See [Appendix A3](#)

**REQUIREMENTS:**

<b>Gloss category</b>	<b>Gloss range</b>	<b>Acceptable variation*</b>
<b>1 (matt)</b>	0 - 30	+/- 5 units
<b>2 (satin)</b>	31 - 70	+/- 7 units
<b>3 (gloss)</b>	71 - 100	+/- 10 units

(\* permissible variation from the nominal value specified by the coating supplier)

## 2.3 Coating thickness

### ISO 2360

The thickness of the organic coating on each part to be tested shall be measured on the significant surface at not less than *five measuring areas* (appr.1 cm<sup>2</sup>).

**REQUIREMENTS:**Powder coating<sup>3</sup>

Class 1	:	60 µm
Class 1.5	:	60 µm
Class 2	:	60 µm
Class 3	:	50 µm
Two-coat powder coating (classes 1 and 2)	:	110 µm
Two-coat PVDF powder coating	:	80 µm

Liquid coating

To be defined by the liquid coating supplier and documented within a technical data sheet with the approval of the Executive Committee.

Other organic coatings may require different thicknesses, but they shall only be applied with the approval of the Executive Committee.

**Final assessment**

None of the measured values shall be less than 80% of the specified minimum value otherwise the thickness test as a whole will be considered unsatisfactory.

The results shall be assessed as shown by **four typical examples** (minimum thickness for coatings of 60 µm):

Example 1:

Measured values in µm : 82, 68, 75, 93, 86 average: 81

Rating: This sample is satisfactory.

Example 2:

Measured values in µm : 75, 68, 63, 66, 56 average: 66

Rating: This sample is good because the average thickness is more than 60 µm and because no value measured is less than 48 µm (80% of 60 µm).

<sup>3</sup> There are different classes of coating powders that meet different requirements. The particular class is stated in the approval.

**Example 3:**

Measured values in  $\mu\text{m}$  : 57, 60, 59, 62, 53 average: 58

Rating: This sample is unsatisfactory and comes under the heading "rejected samples" in table § [5.1.6](#).

**Example 4:**

Measured values in  $\mu\text{m}$  : 85, 67, 71, 64, 44 average: 66

Rating: This sample is unsatisfactory although the average thickness is more than 60  $\mu\text{m}$ . The inspection is unsatisfactory because the measured value of 44  $\mu\text{m}$  is below the tolerance limit of 80% (48  $\mu\text{m}$ ).

## 2.4 Adhesion

### 2.4.1 Dry adhesion

**ISO 2409**

An adhesive tape with an adhesive strength between 6 N per 25 mm width and 10 N per 25 mm width shall be used. The tape shall be at least 25 mm wide.

The spacing of the cuts shall be 1 mm for organic coating thicknesses of up to 60  $\mu\text{m}$ , 2 mm for thicknesses between 60  $\mu\text{m}$  and 120  $\mu\text{m}$ , and 3 mm for thicknesses over 120  $\mu\text{m}$ .

**REQUIREMENTS:**

The result shall be 0.

### 2.4.2 Wet adhesion

Immerse a sample for two hours in boiling demineralised water (maximum 10  $\mu\text{S}/\text{cm}$  at 25°C). Remove the test sample and allow it to cool down to room temperature. After one hour but within a two hours timeframe, a cross-cut shall be made according to § 2.4.1

**REQUIREMENTS:**

No sign of detachment or blistering. Cross-cut value 0. Colour change is acceptable.

## 2.5 Buchholz Indentation

**ISO 2815****REQUIREMENTS:**

Minimum 80 at the required thickness.

## 2.6 Cupping test (only for the approval of organic coatings)

All organic coatings except class 1.5, 2 and 3 powder coatings: **ISO 1520**

Class 1.5, 2 and 3 powder coatings:

**ISO 1520** followed by a tape pull adhesion test as specified below:

Apply an adhesive tape (see § [2.4](#)) to the significant surface of the test panel following the mechanical deformation. Cover the area by pressing down firmly against the coating to eliminate voids or air pockets. Pull the tape off sharply at right angles to the plane of the panel after 1 minute.

**REQUIREMENTS:**

Minimum 5 mm for powder coatings (classes 1, 1.5, 2 and 3)

Minimum 5 mm for liquid coatings except

- two-component liquid coatings: minimum 3 mm
- water-thinnable liquid coatings: minimum 3 mm

Minimum 5 mm for electrophoretic coatings

The test shall be performed on an organic coating with a thickness approximating the minimum required.

In case of negative result, the test shall be repeated on a panel coated with a thickness of

- Classes 1, 1.5 and 2: 60 to 70  $\mu\text{m}$
- Class 3: 50 to 60  $\mu\text{m}$

Using normal corrected vision, the organic coating shall not show any sign of cracking or detachment, except for class 1.5, 2 and 3 powder coatings.

Class 1.5, 2 and 3 powders coatings:

Using normal corrected vision, the organic coating shall not show any sign of detachment following the tape pull adhesion test.

## 2.7 Bend test

All organic coatings except class 1.5, 2 and 3 powder coatings: **ISO 1519**

Class 1.5, 2 and 3 powder coatings:

**ISO 1519** followed by a tape pull adhesion test as specified below:

Apply an adhesive tape (see § 2.4) to the significant surface of the test panel following the mechanical deformation. Cover the area by pressing down firmly against the coating to eliminate voids or air pockets. Pull the tape off sharply at right angles to the plane of the panel after 1 minute.

The test shall be performed on an organic coating with a thickness approximating the minimum required.

In case of a negative result, the test shall be repeated on a panel coated with a thickness of

- Classes 1, 1.5 and 2: 60 to 70  $\mu\text{m}$
- Class 3: 50 to 60  $\mu\text{m}$

**REQUIREMENTS:**

Bending around a 5 mm mandrel for all organic coatings except for two-component and water-thinnable liquid coatings. For these, use an 8 mm mandrel.

Using normal corrected vision, the coating shall not show any sign of cracking or detachment, except for class 1.5, 2 and 3 powders coatings.

Class 1.5, 2 and 3 powders coatings:

Using normal corrected vision, the organic coating shall not show any sign of detachment following the tape pull adhesion test.



## 2.8 Impact test

### (for powder coatings only)

The impact shall be carried out on the reverse side, whereas the results shall be assessed on the coated side.

- Class 1 powder coatings (one- and two-coat), energy: 2.5 Nm: **ISO 6272-2 / ASTM D 2794** (indenter diameter: 15.9 mm)
- Two-coat PVDF powder coatings, energy: 1.5 Nm: **ISO 6272-1 or ISO 6272-2 / ASTM D 2794** (indenter diameter: 15.9 mm)
- Class 1.5, 2 and 3 powder coatings, energy: 2.5 Nm: **ISO 6272-1 or ISO 6272-2 / ASTM D 2794** (indenter diameter: 15.9 mm) followed by a tape pull adhesion test as specified below.

Apply an adhesive tape (see § 2.4) to the significant surface of the test panel following the mechanical deformation. Cover the area by pressing down firmly against the organic coating to eliminate voids or air pockets. Pull the tape off sharply at right angles to the plane of the panel after 1 minute.

The test shall be performed on an organic coating with a thickness approximating the minimum required.

In case of a negative result, the test shall be repeated on a panel coated with a thickness of:

- Class 1, 1.5 and 2: 60 to 70 µm
- Class 3: 50 to 60 µm

### REQUIREMENTS:

Using normal corrected vision, the organic coating shall not show any sign of cracking or detachment, except for class 1.5, 2 and 3 powder coatings.

#### Class 1.5, 2 and 3 powder coatings:

Using normal corrected vision, the organic coating shall not show any sign of detachment following the tape pull adhesion test.

## 2.9 Resistance to humid atmospheres containing sulphur dioxide

**ISO 22479** Method B (0,2 l SO<sub>2</sub> - 24 cycles). X-shape scribe mark with a width of 1 mm shall be made to cut the organic coating down to the metal.

### REQUIREMENTS:

No infiltration exceeding 1 mm on both sides of the scratch, and no change in colour<sup>4</sup> or blisters in excess of 2 (S2) according to ISO 4628-2.

The crossing point of the X-shape scribe mark, has to be included in the evaluation.

---

<sup>4</sup> If there is any colour change, the samples shall be heated at 105°C for 30 minutes and a new assessment of the colour change shall be made.  
Dark / brown spots shall be cleaned by polishing (e.g., pumice flour sludge with melamine pad) and a new assessment of the colour shall be made.



## 2.10 Acetic acid salt spray resistance

**ISO 9227.** A X-shape scribe mark with a width of 1 mm shall be made to cut the organic coating down to the metal. The test shall be carried out on three test pieces of AA 6060 or AA 6063.

For all organic coatings except class 3 powder coatings: testing time: 1000 hours

For class 3 powder coatings: testing time: 2000 hours

### REQUIREMENTS:

No blistering in excess of 2 (S2) according to ISO 4628-2. An infiltration of maximum 16 mm<sup>2</sup> is allowed over a scratch length of 10 cm but the length of any single infiltration shall not exceed 3 mm according to EN 12206-1.

The crossing point of the X-shape scribe mark, has to be included in the evaluation.

The inspector takes three test pieces from different lots. The results are classified according to the scale below:

- A. 3 samples satisfactory = 0 sample unsatisfactory
- B. 2 samples satisfactory = 1 sample unsatisfactory
- C. 1 sample satisfactory = 2 samples unsatisfactory
- D. 0 sample satisfactory = 3 samples unsatisfactory

### Final assessment of the AASS test:

RATING	CORRECTIVE ACTION	
	APPROVAL (GRANTING/RENEWAL)	LICENCE (GRANTING/RENEWAL)
<b>A</b> satisfactory	No action	No action
<b>B</b> satisfactory	No action	▶ Notification to the coater
<b>C</b> unsatisfactory	<ul style="list-style-type: none"> <li>▶ Repetition of the acetic acid salt spray resistance test.</li> <li>▶ If the result of this second test is C or D, all tests shall be repeated.</li> </ul>	▶ Repetition of the AASS test. If the result of this second test is C or D, the inspection shall be repeated.
<b>D</b> unsatisfactory	▶ All laboratory tests shall be repeated.	▶ The inspection shall be repeated

## 2.11 Machu test

### (Accelerated corrosion test, on extruded sections of AA 6060 or AA 6063 only)

Before immersion, a X-shape scribe mark with a width of 1 mm shall be made on the significant surface with a special tool to cut the coating down to the metal. If the dimensions of the sample are smaller than 70 x 70 mm, one scratch will be made lengthwise.

### Test solution:

- NaCl : 50 ± 1 g/l
- CH<sub>3</sub>COOH (Glacial) : 10 ± 1 ml/l
- H<sub>2</sub>O<sub>2</sub> (30%) : 5 ± 1 ml/l





Temperature :  $37 \pm 1$  °C  
Testing time :  $48 \pm 0.5$  hours

The pH of this solution is 3.0 - 3.3. After 24 hours, another 5 ml/l of hydrogen peroxide (H<sub>2</sub>O<sub>2</sub> 30%) shall be added, and the pH adjusted with glacial acetic acid or caustic soda. A new solution shall be prepared for each test.

#### REQUIREMENTS:

No infiltration exceeding 0.5 mm on both sides of the scratch.

The crossing point of the X-shape scribe mark, has to be included in the evaluation.

The inspector takes three test pieces from different lots. The results are classified according to the scale below:

- |    |                        |   |                          |
|----|------------------------|---|--------------------------|
| A. | 3 samples satisfactory | = | 0 sample unsatisfactory  |
| B. | 2 samples satisfactory | = | 1 sample unsatisfactory  |
| C. | 1 sample satisfactory  | = | 2 samples unsatisfactory |
| D. | 0 sample satisfactory  | = | 3 samples unsatisfactory |

#### Final assessment of the Machu test:

RATING	ASSESSMENT
A	satisfactory
B	satisfactory
C	unsatisfactory
D	unsatisfactory

## 2.12 Accelerated weathering test

### 2.12.1 Accelerated weathering test for classes 1, 1.5 and 2

#### ISO 16474-2 Method A (daylight filters) – Cycle 1 (102 min dry/18 min wet)

##### Classes 1, 1.5 and 2

For granting an approval, three panels shall be tested for every single colour in different areas of the climatic chamber.

For renewals, only one panel shall be tested, except for class 2 powder coatings and for banned colours which shall also be tested in triplicate.

The position of all panels shall be changed approximately every 250 hours.

After 1000 hours exposure the test panels shall be rinsed with demineralised water and checked for:

- Gloss variation: ISO 2813 - angle of incidence 60°
- Colour change: CIELAB  $\Delta E^*_{ab}$  using the formula in ISO 11664-4, measurement including specular reflection.

Three colour measurements are to be made on the test panels before and after the accelerated weathering test.

**REQUIREMENTS:**Gloss retention<sup>5</sup>

The gloss retention shall be at least

- 50% for class 1
- 75% for class 1.5
- 90% for class 2

Colour change:

The colour change  $\Delta E$  shall not be greater than

- the limits prescribed in [Appendix A12](#) for class 1
- 75% of the limits prescribed in [Appendix A12](#) for class 1.5
- 50% of the limits prescribed in [Appendix A12](#) for class 2

In case of an unsatisfactory result, an additional visual assessment shall be carried out for

- category 1 organic coatings;
- organic coatings with structured appearance in all gloss categories;
- organic coatings with a metallic or metallised effect (see [Appendix A4](#))
- organic coatings in light colours ( $L > 70$ )

**Final assessment of the accelerated weathering test (in the case of triplicate testing)**

The results of the instrumental measurements shall be evaluated according to the following criteria:

PANELS (individual values)	ASSESSMENT
3 panels OK	satisfactory
2 panels OK and 1 panel NOT OK	satisfactory
1 panel OK and 2 panels NOT OK	unsatisfactory
3 panels NOT OK	unsatisfactory

**2.12.2 Accelerated weathering test for class 3**

For class 3 the accelerated weathering test is replaced by a Florida exposure test of 3 years.

**REQUIREMENTS:**Gloss retention:

The gloss retention shall be at least 80% after 3 years

Colour change:

The colour change  $\Delta E$  shall not be greater than 50% of the limits prescribed in [Appendix A12](#)

---

5

$$\text{Gloss retention} = \frac{\text{gloss value measured after testing}}{\text{initial gloss value}} \times 100$$



## 2.13 Natural weathering test

### Exposure in Florida according to ISO 2810

The test shall start in April.<sup>6</sup>

#### Class 1 organic coatings

Samples shall be exposed facing 5° south for **1 year**.

4 test panels per colour shade are required (3 for weathering and 1 reference panel)

#### Class 1.5 organic coatings

Samples shall be exposed facing 5° south for **2 years with an annual evaluation**.

7 test panels per colour shade are required (3 per year for weathering and 1 reference panel).

#### Class 2 organic coatings

Samples shall be exposed facing 5° south for **3 years with an annual evaluation**.

10 test panels per colour shade are required (3 per year for weathering and 1 reference panel).

#### Class 3 organic coatings

Samples shall be exposed facing 45° south for **10 years**.

All the test panels shall be cleaned and measured annually by the laboratory in Florida.

After 3, 5, and 7 years, three test panels will be sent back to the QUALICOAT laboratory in charge for evaluation. The remaining three test panels will finally be sent back to the laboratory in charge at the end of the 10-year exposure period.

#### For all organic coatings:

Dimensions of the test panels: approx. 100 x 305 x 0.8 - 1 mm

After exposure, the exposed panels shall be cleaned using the following method:

Immerse in demineralised water (maximum temperature of 25°C) with a 1% surface-active agent for 24 hours, and then clean by wiping with a soft sponge with tap water applying gentle pressure, or using any other method approved by the Technical Committee. This process shall not scratch the surface.

The gloss shall be measured according to ISO 2813, at an angle of 60°.

The average is taken from the colorimetric measurements. The conditions for measurement and colorimetric evaluation are:

- Colour variation:  $\Delta E$  CIELAB formula according to ISO 11664/4, measurement including specular reflection.
- The colorimetric evaluation shall be made for the standard illuminant D65 and the ten-degree normal observer.

To determine the gloss and colour, three measurements will be made on the cleaned panels before and after the weathering test. These measurements shall be made at different points at least 50 mm apart.

---

<sup>6</sup> A complete procedure is available.

**REQUIREMENTS:****Gloss**

The gloss retention shall be at least 50% for class 1 organic coatings.

The following values apply to class 1.5 organic coatings:

- After 1 year in Florida : at least 65%
- After 2 years in Florida : at least 50%

The following values apply to class 2 organic coatings:

- After 1 year in Florida : at least 75%
- After 2 years in Florida : at least 60%
- After 3 years in Florida : at least 50%

The following values apply to class 3 organic coatings:

- After 3 years in Florida : at least 80%
- After 5 years in Florida : at least 70%
- After 7 years in Florida : at least 60%
- After 10 years in Florida : at least 50%

**Colour change**

For class 1, 1.5 and 2 organic coatings the  $\Delta E$  values shall not exceed the maximum values prescribed in the annexed tables (see [Appendix A12](#)).

The following values apply to class 3 organic coatings:

- After 3 years in Florida : max. 50% of the limits prescribed in [Appendix A12](#)
- After 10 years in Florida : within the limits prescribed in the table.

**VISUAL ASSESSMENT**

In case of unsatisfactory result, an additional visual assessment shall be carried out for

- category 1 organic coatings
- organic coatings with structured appearance in all gloss categories
- organic coatings with a metallic or metallised effect (see [Appendix A4](#))
- organic coatings in light colours ( $L > 70$ )

In case of doubt, the Florida WG may carry out an additional visual assessment on coated panels in all classes and categories even if they do not belong to the above list of candidates for visual assessment.

The decision of the Florida WG after visual assessment is non-reversible.

**2.14 Polymerisation test**

Prescribed solvent for liquid coatings: MEK or as specified by the liquid coating material's manufacturer and approved by the Technical Committee.

Prescribed solvent for powder coatings: xylene or as specified by the powder coating material's manufacturer and approved by the Technical Committee.

Saturate a swab of cotton wool with solvent. Within 30 seconds, rub it lightly back and forth 30 times in each direction over the part to be tested. Wait 30 minutes before making the assessment.

The polymerisation quality is assessed according to the following ratings:

1. The coating is very dull and quite soft.
2. The coating is very dull and can be scratched with a fingernail.
3. Slight loss of gloss (less than 5 units)
4. No perceptible change. Cannot be scratched with a fingernail.

**REQUIREMENTS:**

Ratings 3 and 4 are satisfactory.

Ratings 1 and 2 are unsatisfactory.

For powder coatings, this test is optional in in-house control; it is merely indicative and cannot alone cast doubt upon the quality of the coating.

## 2.15 Resistance to mortar

The test shall be performed according to the **EN 12206-1** standard with the following changes:

- Amount of water: 60 – 65 g tap water
- Portions: 1 Portion (ø 40 mm and 5-6 mm thickness) instead of 4 portions as mentioned in the standard.

**EVALUATION:**

Distance: 20 - 40cm

Angle: not fixed

Light: D65 in the light cabinet

**REQUIREMENTS:**

The mortar shall be easy to remove without leaving any residues. Any mechanical damage to the organic coating caused by grains of sand shall be disregarded.

Any change in the appearance/colour of organic coatings with metallic or metallised effect shall not exceed 1 on the reference scale (see [Appendix A4](#)). All other colours shall not show any change.

## 2.16 Constant climate condensation water test

### ISO 6270-2

A X-shape scribe mark with a width of at least 1 mm shall be made to score the organic coating down to the metal.

The test duration is 1000 hours for all organic coatings except class 3 and 2000 hours for class 3 organic coatings.

**REQUIREMENTS:**

No blistering in excess of 2 (S2) according to ISO 4628-2; the maximum infiltration at the cross is 1 mm.

The crossing point of the X-shape scribe mark, has to be included in the evaluation.



## 2.17 Sawing, milling and drilling

The good quality of the organic coating is tested using sharpened tools suitable for aluminium.

### REQUIREMENTS:

The coating shall not crack or chip when sharp tools are used.

## 2.18 Filiform corrosion test

### TEST METHOD

**ISO 4623–2** with the following modification:

Size of samples: preferably 150 x 70 mm

The scratches shall be made as follows:

On each sample, make two scribe marks perpendicular to each other, each at least 30 mm long and at a distance of at least 10 mm from each other and from the edges.

The scribe marks shall be 1 mm in width with a rectangular shape.

If the samples have a small width (<50 mm), no horizontal scribe mark (perpendicular to the extrusion direction) shall be made.

Corrosion is produced by dripping hydrochloric acid (concentration 37%, density 1.18 g/cm<sup>3</sup>) along the scratches for 1 minute. Then the acid shall be removed by dabbing gently with a piece of cloth or laboratory paper and the sample shall be allowed to stand at laboratory conditions for 60 minutes.

The samples shall then be put into the test cabinet at 40 ±2°C and 82 ±5% relative humidity for 1000 hours in a horizontal position.

### ASSESSMENT

**Based on the ISO 4628-10 standard.**

Using a ruler, determine the length of the longest filament L (mm) as described in the ISO 4628-10 standard, reporting the results for the two scribe marks separately.

The worst results of each test sample shall be reported for the final assessment.

In case of regular filiform corrosion, use **method 1**.

For irregular filiform corrosion, use **method 2**.

### REQUIREMENTS:

**Acceptable limits within 10 cm on each side of the scratch:**

L (longest filament) ≤ 4 mm

M (average length of filaments) ≤ 2 mm

The inspector takes three test pieces from different lots. The results are classified according to the scale below:

A. 3 samples satisfactory = 0 sample unsatisfactory

B. 2 samples satisfactory = 1 sample unsatisfactory

C. 1 sample satisfactory = 2 samples unsatisfactory

D. 0 sample satisfactory = 3 samples unsatisfactory



**Final assessment of the FFC test:**

RATING	GRANTING / RENEWAL OF	
	APPROVAL OF PRETREATMENT SYSTEMS	SEASIDE ENDORSEMENT
<b>A</b>	<b>Satisfactory</b>	<b>Satisfactory</b>
<b>B</b>	<b>Satisfactory</b>	<b>Satisfactory with a comment to the licensee</b>
<b>C</b>	<b>Unsatisfactory</b> <ul style="list-style-type: none"> <li>▶ Repetition of the filiform corrosion test.</li> <li>▶ If the result of this second test is C or D, all tests shall be repeated.</li> </ul>	<b>Unsatisfactory</b> <ul style="list-style-type: none"> <li>▶ Repetition of the filiform corrosion test</li> <li>▶ If the result of this second test is C or D, the inspection shall be repeated.</li> </ul>
<b>D</b>	<b>Unsatisfactory</b> <ul style="list-style-type: none"> <li>▶ All laboratory tests shall be repeated.</li> </ul>	<b>Unsatisfactory</b> <ul style="list-style-type: none"> <li>▶ Another complete and unannounced inspection including SEASIDE shall be conducted.</li> </ul>

**2.19 Water spot test**

**TEST METHOD**

The test shall be performed on one panel.

The demineralised water shall be heated up to 60°C in a beaker of the proper size and kept under stirring to uniform temperature.

The test panel shall be immersed for a half in water. Care must be taken not to put the panel in contact with the bottom of the beaker. The panel shall be immersed for 24 hours at 60 ± 1°C. The glass shall be properly covered to avoid water evaporation.

At the end of the test, the panel shall be immediately cooled down in demineralised water at a temperature of ≤ 5°C. It shall then be dried with paper towels without rubbing.

Colour change: ΔE and ΔL CIELAB formula according to ISO 11664-4, measurement including specular reflection.

**REQUIREMENTS:**

**Colour change**

The ΔL value shall be less than 4.

**2.20 Scratch and mar resistance test (Martindale)<sup>7</sup>**

**TEST METHOD - CEN/TS 16611**

The test shall be performed on one panel.

Test panel dimensions: A5 or 150x150 mm. Any deformation of the test panels that could affect the results shall be avoided.

The thickness of the powder coating shall be between 60 µm and 90 µm.

<sup>7</sup> Implementation for data collection with real application by the laboratories from 2020 renewals (Florida exposure 2021–2022/3/4). No consequence on test results in case of failure until 2022 renewals.



The test panel shall be conditioned at  $23 \pm 2^\circ\text{C}$  and  $50 \pm 5\%$  RH for at least 16 hours.

The test surface shall be carefully wiped with a cleaning cloth before and after the test without scratching the surface, before taking gloss measurements.

The test panel shall be fixed on the table of the Martindale tester with a double-sided adhesive tape or other means, provided that the test surface remains substantially flat. The abrasive pad (3M Scotch Pad, CF-RL 7448, ultra-fine, grey) shall be fixed on the holder guide plate with a double-sided adhesive tape.

The holder for scrub material consists of a guide plate with an inner diameter of  $90 \pm 0,5$  mm and a spindle (no additional ring weight) for a total of  $155 \pm 2$  g.

The testing instrument shall be moved across the surface in a Lissajous figure of 1.5 Martindales, i.e. 24 movements (1 Martindale = a Lissajous figure with 16 movements).

The test shall be carried out at  $23 \pm 2^\circ\text{C}$  and  $50 \pm 5\%$  RH.

A new abrasion pad (3M Scotch Pad, CF-RL 7448, ultra-fine, grey) shall be used for each test and sample.

According to Figure 1, five gloss measurements (in accordance with ISO 2813 at a  $60^\circ$  angle of incidence) shall be made on the panels before and after the Martindale test. For the five measurements the gloss measurement device has to be placed and moved on the coated surface according figure 1.

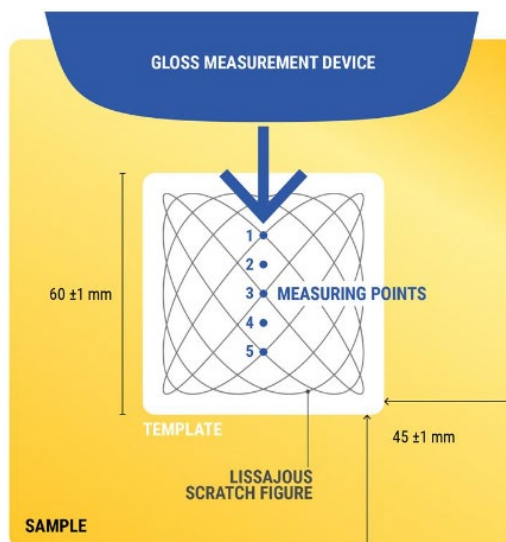

Figure 1: Schematic representation of the measuring points on the sample

**REQUIREMENTS:**

Gloss retention<sup>8</sup>

The average gloss retention shall be at least

- 60% for organic coatings with a structured appearance in all classes
- 40% for class 1 and 1.5 smooth organic coatings
- 30% for class 2 and 3 smooth organic coatings

$$^8 \text{ Gloss retention} = \frac{\text{gloss value measured after testing}}{\text{initial gloss value}} \times 100$$





# Chapter 3

## Work Specifications



## 3 Work Specifications

### 3.1 Storage of the products to be treated and layout of equipment

#### 3.1.1 Storage

##### Aluminium

The products to be treated shall either be stored in a separate room or at least a good distance away from the processing baths. They shall also be protected against condensation and dirt.

##### Powder and liquid coating materials

Coating materials shall be stored in accordance with the specifications of the coating material's manufacturer.

##### Chemical products

Chemical products shall be stored in accordance with the specifications of the chemical material's manufacturer.

#### 3.1.2 Layout of equipment

The layout of the equipment should be designed to avoid any form of contamination.

### 3.2 Surface preparation

The surfaces of the parts to be treated shall be clean and free of any oxidation, scale or soils, oil, grease, lubricants, hand sweat or any other contamination that may be detrimental to the final finish. The parts shall therefore be etched before conversion coating. Two preliminary pretreatments are defined: **standard** (compulsory) and **enhanced** (voluntary, for SEASIDE endorsement).

The products to be treated shall either be attached to the jig individually or placed in a basket as stipulated in [Appendix A7](#). Each product shall be treated fully in one pass, at each stage.

Cast accessories have special requirements (see [Appendix A5](#) – Special specifications for coatings on aluminium accessories for architectural applications under the QUALICOAT quality label).

It is not permissible, to apply any etching or conversion coating process, which is not stipulated in [Chapter 3](#) or [Appendix A6](#) of QUALICOAT Specifications. In the case of modified processes or new technologies, which are not stipulated in [Chapter 3](#) or [Appendix A6](#), a preliminary sampling and testing (PST) of the etching and/or conversion coating process according to [Appendix A6b](#) shall be first required. Only after this preliminary testing is successfully completed, an approval (A-No.) of the pretreatment system according to [Appendix A6](#) can follow.

#### 3.2.1 Etching stage

All chemical pretreatments for powder and liquid organic coatings shall include an aluminium etching stage consisting of one or more steps.

The following types of etching are admissible:



- **Type A : acid etching**
  - Type A1: simple acid etching
  - Type A2: acid etching + acid etching
- **Type AA : dual etching**
  - Type AA1: alkaline etching and acid etching
  - Type AA2: acid etching + alkaline etching + acid etching.

The etching degree is measured by taking the weight of a test sample before and after etching. If a sample cannot be taken, the method used to measure the etching degree shall be defined in agreement with the General Licensee or directly with QUALICOAT in countries without a General Licensee. Any new coating line shall be designed to allow sampling after each stage of the chemical treatment.

The etching degree is measured on extruded sections of alloy AA6060 or AA6063. If the main production on a coating line is on sheets or alloys other than AA6060 or AA6063 the inspector should also check the etching degree with the material actually used.

An etching degree is not specified for cast accessories. Etching is optional for such products.

Two preliminary pretreatments are defined:

**a) Standard pretreatment (compulsory)**

The total etching degree shall be at least 1.0 g/m<sup>2</sup>.

**b) Enhanced pretreatment (for SEASIDE endorsement)**

This pretreatment includes degreasing either in an independent step or in a combined degreasing/etching step.

The total etching degree shall be at least 2.0 g/m<sup>2</sup>.

For type AA (dual etching) the two final steps shall be at least 0.5 g/m<sup>2</sup>.

Licensees who wish to have the endorsement SEASIDE on their licence certificate shall apply to their General Licensee or directly to QUALICOAT in countries without a General Licensee.

### 3.3 Chemical conversion coatings

After conversion coating pre-treated aluminium shall not be stored for more than 16 hours. As a rule, they should be coated immediately after pretreatment. The risk of insufficient adhesion increases the longer the products are stored.

Pre-treated aluminium shall never be stored in an atmosphere that is dusty and detrimental to them. Good atmospheric conditions shall always be maintained in the storage area. All workers handling pre-treated aluminium shall wear clean textile gloves to avoid contamination of the surface.

#### 3.3.1 Chromate conversion coatings

This chemical chromate or chromate-phosphate conversion shall be carried out according to EN 12487.

The conductivity of the final rinse preceding chemical chromate conversion's step shall comply with the manufacturer's specifications and be checked by the inspector.



Demineralised water shall be used for the final rinse after chemical chromate conversion before drying. The conductivity of the dripping water shall not exceed a maximum of 30  $\mu\text{S}/\text{cm}$  at 20°C.

Any spray and cascade installation shall be designed (or retrofitted) to allow sampling for measuring the conductivity as described above. The conductivity of the dripping water should only be measured for open sections and not for hollow sections.

In the event that it is not possible to measure the conductivity of the dripping water for immersion installation, the conductivity of the rinse water in the process tank shall be measured with a maximum conductivity of 15  $\mu\text{S}/\text{cm}$  at 20°C before immersion starts.

The weight of the chromate conversion coating shall be between 0.6 and 1.2  $\text{g}/\text{m}^2$  for chemical chromate conversion (yellow coating) and between 0.6 and 1.5  $\text{g}/\text{m}^2$  for chemical chromate-phosphate conversion (green coating).

Every two months a production sample shall be sent to the chemical chromate conversion manufacturer who shall carry out an acetic acid salt spray resistance test. The test results shall be communicated to the coater within a period of maximum four months.

The results and any corrective actions communicated by the chemical chromate conversion manufacturer shall be entered and retained along with the related shipping details in records readily accessible to the inspector. Unsatisfactory values shall have no influence on the result of a QUALICOAT inspection.

### 3.3.2 Chemical pretreatments

Chemical pretreatments other than the chromate conversion coatings described above may not be used until they have been approved by QUALICOAT, following a test programme set out in [Appendix A6](#).

In terms of rinsing, there are two types of chemical pretreatment systems according to [Appendix A6](#):

#### a) Rinse system

There is a final rinse after the conversion coating stage.

The conductivity of the dripping water of all chemical pretreatment systems with a final rinse shall not exceed a maximum of 30  $\mu\text{S}/\text{cm}$  at 20°C.

Any spray and cascade installation shall be designed (or retrofitted) to allow sampling for measuring the conductivity as described above. The conductivity of the dripping water should only be measured for open sections and not for hollow sections.

In the event that it is not possible to measure the conductivity of the dripping water for immersion installation, the conductivity of the rinse water in the process tank shall be measured with a maximum conductivity of 15  $\mu\text{S}/\text{cm}$  at 20°C before immersion starts.

#### b) No-rinse system

There is no final rinse after the conversion stage (a spray mist step after the conversion stage is not considered as final rinse).

The conductivity of the dripping water of the last rinse before the conversion stage shall not exceed a maximum conductivity as prescribed by the chemical supplier in the manual adapted to the coating line, which shall not be higher than 100  $\mu\text{S}/\text{cm}$  at 20°C.



Any installation should preferably be designed (or retrofitted) to allow sampling for measuring the conductivity as described above.

In the event that it is not possible to measure the conductivity of the dripping water, the conductivity of the last rinse water applied on the pieces shall not exceed a maximum conductivity as prescribed by the chemical supplier in the manual adapted to the coating line, which shall not be higher than 50% of the limit prescribed for the dripping water.

The weight of the conversion coating shall comply with the manufacturer's specified limits and be checked by the inspector.

The licensees shall use the products as described in the technical data sheet and in the adapted manual provided for the specific coating line by the chemical manufacturer(s) concerning the methods for assessing the quality of the chrome VI-free conversion coating, the device prescribed for analytically determining the coating weight, and the in-house control frequencies. These manual adapted to the coating line shall be accessible to the inspector.

Due to its uncertainty, QUALICOAT does not allow the gravimetric method to measure the weight of the conversion layer below 100 mg/m<sup>2</sup> using an analytical balance with precision 0.1 mg. The X-ray analysis and spectrophotometry are accepted methods for measuring conversion layer weight below 100 mg/m<sup>2</sup>.

Every two months a production sample shall be sent to the chemical manufacturer who shall carry out an acetic acid salt spray resistance test and a coating weight measurement. The test results and the measurements shall be communicated to the coater within a period of maximum four months.

The results and any corrective actions communicated by the chemical manufacturer shall be entered and retained along with the related shipping details in records readily accessible to the inspector. Unsatisfactory values shall have no influence on the result of a QUALICOAT inspection (see [Appendix A6, Section 9](#))

### **3.4 Anodic pretreatment (automatic SEASIDE endorsement)**

Licensees using anodic pretreatment shall ask their coating suppliers to confirm in writing the compatibility of their coating system with this type of pretreatment.

The following minimum requirements shall be met by the coater:

#### **3.4.1 Requirements for In-house Pre-anodising Process**

For off-site pre-anodising please refer to [Appendix A15](#).

##### **3.4.1.1 Surface preparation**

The aluminium surface shall be treated to eliminate all impurities that could pose problems in the anodic pretreatment.

##### **3.4.1.2 Etching**

The aluminium parts (extrusions and sheet, not cast) shall be etched with a minimum etching rate of 2 g/m<sup>2</sup>. In the case of alkaline etching, desmutting shall be necessary.

##### **3.4.1.3 Thickness of the pre-anodised layer**

The anodic pretreatment shall be chosen so as to produce an anodic coating with a thickness of at least 4  $\mu\text{m}$  (not more than 10  $\mu\text{m}$ ) without powdering and without surface flaws.

The anodic pretreatment parameters can be as follows:

- Acid concentration (sulphuric acid): 180-220 g/l
- Aluminium content: 5-15 g/l
- Temperature: 20-30°C ( $\pm 1^\circ\text{C}$  of the temperature chosen by the anodiser)
- Current density: 0.8-2.0 A/dm<sup>2</sup>
- Agitation of the electrolyte

#### **3.4.1.4 Post-treatment and rinsing after pre-anodising**

After anodic pretreatment, the aluminium shall be rinsed for such a time and at such a temperature as is required to remove the acid from the pores and to fulfil the requirements of the wet adhesion test.

Enhancing rinsing with a hot sealing step and/or a passivation step with a QUALICOAT approved chemical pretreatment system or chromate conversion coating is permitted. The rinsing process shall not produce a sealed surface, as this increases the risk of adhesion failure. No-rinse passivation is not permitted when a period of 16 hours has passed.

Sealing additives can decrease the quality of the final product. It is the responsibility of the anodiser and the coater to verify the compatibility with the coating process.

The conductivity of the dripping water of the final rinse prior to coating shall not exceed a maximum of 30  $\mu\text{S/cm}$  at 20°C. The final rinse prior to the coating shall be performed in either the anodising or coating line.

Any spray and cascade installation shall be designed (or retrofitted) to allow sampling for measuring the conductivity as described above. The conductivity of the dripping water should only be measured for open sections and not for hollow sections.

In the event that it is not possible to measure the conductivity of the dripping water for immersion installation, the conductivity of the rinse water in the tank shall be measured with a maximum conductivity of 15  $\mu\text{S/cm}$  at 20°C before immersion starts.

#### **3.4.1.5 Recording of anodising bath test results**

Licensees using this type of anodic pretreatment shall perform and record the following additional tests when processing pre-anodising:

- The acid concentration and aluminium content of the anodising bath shall be analysed once per day.
- The temperature of the anodising bath shall be checked every 8 hours.
- The etching rate shall be checked once per day.
- The thickness of the anodic coating shall be checked (every load).

#### **3.4.2 Requirements for Treatment and Coating of Pre-anodised Aluminium**

Applicable for coaters using in-house or off-site pre-anodising.



### 3.4.2.1 Storage conditions

Pre-anodised aluminium shall never be stored or transported in an atmosphere that is dusty, damp (condensation or similar) and detrimental to it. Good atmospheric and dry conditions shall always be maintained in the storage area and whilst being transported. All workers handling pre-anodised aluminium shall wear clean textile gloves to avoid contamination of the surface.

### 3.4.2.2 Storage time and transportation

Pre-anodised parts shall not be stored for more than 16 hours. However, the parts may be stored (including transportation, where applicable) for up to 72 hours provided that additional rinsing has occurred with demineralised water with a conductivity of maximum 30  $\mu\text{S}/\text{cm}$  at 20°C and drying has taken place prior to coating (no etching allowed). The risk of insufficient adhesion increases the longer the parts are stored.

### 3.4.2.3 Pretreatment and rinsing prior to coating

The coater shall ensure that the aluminium after anodic pretreatment has been rinsed for such a time and at such a temperature as is required to remove the acid from the pores and to fulfil the requirements of the wet adhesion test.

Sealing additives can decrease the quality of the final product. It is the responsibility of the anodiser and the coater to verify the compatibility with the coating process.

Enhancing rinsing with a hot rinsing step and/or a passivation step with a QUALICOAT approved chemical pretreatment system or a chromate conversion coating is permitted. The rinsing process shall not produce a sealed surface, as this increases the risk of adhesion failure.

The conductivity of the dripping water of the final rinse prior to coating shall not exceed a maximum of 30  $\mu\text{S}/\text{cm}$  at 20°C. The conductivity of the dripping water should only be measured for open sections and not for hollow sections.

The rinsing for the chemical conversion coatings shall follow the requirements as described in [§ 3.3.1](#) and [§ 3.3.2](#).

No etching or double passivation is permitted.

### 3.4.2.4 Recording of test results on finished products

Licensees using this type of anodic pretreatment shall perform and record the following additional tests when processing pre-anodising:

- Before application, the wet adhesion test (see [§ 2.4.2](#)) shall be carried out for each coating material (i.e., each colour shade, gloss category, and manufacturer)
- During application, the wet adhesion test shall be performed every 4 hours.

### 3.4.2.5 Cooperation between external anodiser and coater

Only applicable for coaters using off-site pre-anodising.

External anodisers and coaters shall cooperate closely. The test results from the external anodiser shall be delivered to the coater with a delivery note, and the following information shall be included where applicable (i.e., if it was not already described in the general agreement between the external anodiser and the coater):

- Qualanod licence number or quality management system certificate number.



- Description of all pre-anodising process steps (type of surface treatment, chemical composition, temperature, and treatment time).
- Detailed description of rinsing conditions (30  $\mu\text{S}$ ), including information about the usage and type of hot sealing or approved passivation, including parameters, values, and limits.
- Production date and time.
- Number of test panels that are produced in the same lot together with the material.
- Alloy.
- Etching requirements of cast material.
- Location of jiggging marks.

For each delivery, the coater shall communicate the following information to the anodiser:

- Name and licence number of the coater.
- Date of anodising.
- Date of coating.
- Order number.
- Rinsing water conductivity.
- P-No and colour.
- Results of the wet adhesion test.

This information shall be readily available to the inspector.

### 3.5 Electrophoretic coatings

All electrocoated products shall be cleaned by adapted chemical treatment in an alkaline or acid solution before the topcoat is applied. The cleaned surfaces shall be rinsed in demineralised water with a maximum conductivity of 30  $\mu\text{S}/\text{cm}$  at 20°C prior to coating. The surfaces should be wettable with water.

The products shall be top coated immediately.

All workers handling pre-treated parts shall wear clean textile gloves to avoid contamination of the surface.

### 3.6 Drying

After chemical pretreatment and before the application of organic coating, the products shall be dried thoroughly in an oven. For this purpose, a drying oven shall be installed prior to the coating cycle.

For continuous treatment<sup>9</sup> the maximum drying temperature allowed is 100°C.

For discontinuous treatment the products shall be dried at the following temperatures:

- chemical chromate conversion (yellow coating): maximum 65°C
- chemical chromate-phosphate conversion (green coating): maximum 85°C

---

<sup>9</sup> See definition of a continuous line in Chapter 1 - Terminology





The specified temperatures apply to the temperature of the metallic parts and not to the air temperature. The products shall be dried thoroughly before the coating is applied, irrespective of the production method (continuous/discontinuous).

For anodic pretreatment, the drying temperature shall be less than 80°C to prevent the anodic coating from being sealed.

Chemical pretreatment systems other than chromate conversion coatings shall be dried following the manufacturer's specifications.

## 3.7 Coating and stoving

### 3.7.1 Coating

For architectural applications the licensee shall use only organic coatings approved by QUALICOAT in accordance with [Chapter 4](#) "Approval of Organic Coatings".

#### Best before date expiry

At the licensee's request, permission to extend the use of expired powders may be given by the powder manufacturer. It is the powder manufacturer's responsibility to stipulate which additional tests need to be carried out either by themselves or by the licensee. Following satisfactory results, the powder manufacturer shall give written permission to the coater indicating the new "best before" date.

An extension of the best before date of banned or suspended colours shall not be permitted.

### 3.7.2 Stoving

The coating line shall have an oven for drying and one for curing; in cases where the oven is combined (performing both functions), an efficient control system for temperature and time shall be in place to ensure that suppliers' recommended conditions can be followed.

The conditions between the spray booth and the oven shall be absolutely free of dust and contamination.

All organic coatings shall be stoved immediately after application. The oven shall bring the products to the required temperature and maintain them at that temperature for the whole length of the prescribed time.

The temperatures of the products and the stoving times shall match the values recommended in the manufacturer's technical specifications. If the coater uses a calculation of the curing index, the value shall meet the coating suppliers' recommendations.

It is recommended to keep the difference in metal temperature during polymerisation phase below 20°C.

It should be possible to measure the temperature over the whole length of the oven.

The oven shall be fitted with an alarm system which operates as soon as the temperature moves outside the prescribed temperature range.

### 3.8 Laboratory

The production site shall have laboratory facilities which are separate from the production facilities. The laboratory shall have the apparatus and chemicals necessary for testing and controlling the process solutions and finished products. The laboratory shall at least be equipped with the following apparatus and equipment:

- 1) Specular glossmeter suitable to measure in 60° incident light mode
- 2) 2 instruments for measuring coating thickness according to **ISO 2360** (corresponding calibration standards <60 µm and >60 µm)
- 3) 1 analytical balance with precision 0.1 mg (2 calibrated weights for in-house adjustment)
- 4) Cutting tools and instruments necessary for performing the adhesion test
- 5) Impact tester
- 6) Recorder for stoving temperature and time with four different measuring points, three on the parts and one to measure the air temperature
- 7) Conductivity meter (calibration solution ≤ 100 µS/cm)
- 8) Apparatus for testing resistance to cracking on bending
- 9) Test solutions for the polymerisation test
- 10) pH-meter (calibration solution corresponding to the pH value of the coating line) if specified in the technical data sheet and the manual adapted to the coating line provided by the chemical manufacturer, as described in Appendix A6.
- 11) Device prescribed for the analytical coating weight determination (only for chemical pretreatment according to § [3.3.2](#))

Each piece of apparatus shall have a data sheet showing the apparatus identification number and calibration records.

The oven temperature recorder shall be checked, and the results shall be registered at least twice per year.

The laboratory conditions may differ from those prescribed by ISO standards for mechanical tests.

### 3.9 In-house control

Licensees holding the quality label shall monitor their production processes and inspect their finished products in accordance with [Chapter 6](#).

### 3.10 Operating Instructions

For every test the licensee shall have the relevant standards or operating instructions based on these standards. These standards or operating instructions shall be available to all operators carrying out the tests.



### 3.11 Registers

The licensee shall maintain registers for:

- production of QUALICOAT products
- in-house control
- tests carried out by the chemical manufacturers (as defined in § [3.3.1](#), § [3.3.2](#) and [Appendix A6](#))
- customers' complaints.



# Chapter 4

## Approval of Organic Coatings



## 4 Approval of Organic Coatings

The organic coatings used in quality label coating shall be approved before they may be used. It is not permissible to apply a second coat for organic coating materials that are intended and approved for the application of a single coat.

When a two-coat organic coating material (primer and coloured topcoat) approved by QUALICOAT is used, the licensee may apply either a class 1, 1.5 or class 2 topcoat on the approved primer provided that the powder supplier gives written authorisation for it. It is not necessary to have an approval for each combination. However the organic coating material (primer and coloured topcoat) used by the licensee shall originate from the same manufacturer.

Any modification of the chemical properties of the binder (resin(s) and/or hardening agent(s) is tantamount to a new product and absolutely requires a new QUALICOAT approval. Furthermore, if the physical appearance of the final coating is modified, a new specific QUALICOAT approval shall be required (see [Appendix A3](#)).

Special approvals or extensions of existing approvals may be granted for specific colours or applications such as decoration, as defined in QUALICOAT (QUALIDECO) Specifications, or for postforming, as defined in [Appendix A14](#).

The concept of RAL families for class 2 and class 3 approvals is described in [Appendix A11](#).

### 4.1 Granting of an approval

Organic coating materials have a reference identifying a specific chemical formulation. Every organic coating material can have a variety of gloss levels (matt, satin or gloss) and appearances (see [Appendix A3](#)).

Approvals are granted for each organic coating material, gloss level and appearance.

Additionally, class 3 approvals are granted by lightness category<sup>10</sup>

Approvals are usually requested by the manufacturers themselves, but any third party interested may apply for approval of an organic coating material he wishes to sell under his own brand name provided that he clearly informs the General Licensee and QUALICOAT of the sources used.

An approval is granted for one single production site. If an approval holder changes his source, he shall advise the General Licensee and QUALICOAT and have such new organic coating materials approved.

In order for an approval to be granted, the following conditions shall be met:

#### 4.1.1 Technical information

##### Technical Data Sheet

The manufacturer shall provide the coaters and the laboratory in charge with the relevant technical data sheet. It shall include at least the following information:

- QUALICOAT + P-No.
- Product description

---

<sup>10</sup> See [Appendix A11](#)

- Curing conditions including a curing window with a minimum of 2 temperatures and minimum and maximum time for each temperature.  
Eg.: - 12 min. to 30 min at 180°C
  - 7 min. to 20 min at 190°C
  - 5 min. to 15 min at 200°C
- Shelf life and maximum storage temperature (XX months <YY°C)
- Fire classification information, if available (e.g., EN 13501-1 – A2 s1d0).

#### Label

Labels shall include at least the following information:

- QUALICOAT + P-No.
- Colour description
- Product code
- Batch number
- Gloss value
- Curing conditions (min. and max. for time and temperatures)
- Best before date<sup>11</sup> at <YY°C)

#### **4.1.2 Minimum laboratory equipment**

- 1) Specular glossmeter
- 2) Instruments for measuring coating thickness
- 3) Apparatus for testing resistance to cracking on bending
- 4) Cutting tools and instruments necessary for performing the adhesion test
- 5) Instrument for measuring indentation hardness
- 6) Apparatus for cupping test
- 7) Impact tester
- 8) Apparatus for controlling stoving temperature and time
- 9) System for checking polymerisation
- 10) Spectrophotometer
- 11) Apparatus for accelerated weathering test<sup>12</sup>
- 12) Light cabinet
- 13) RAL GL cards
- 14) Device to measure particle size

Each piece of apparatus shall have a data sheet showing the apparatus identification number and calibration checks.

#### **4.1.3 Tests for granting an approval<sup>13</sup>**

The following tests shall be made:

- Colour ([2.1](#))
- Gloss ([2.2](#))
- Coating thickness ([2.3](#))

---

<sup>11</sup> See section [3.7.1](#)

<sup>12</sup> The accelerated weathering test can be outsourced and carried out by a QUALICOAT approved laboratory or another laboratory accredited for this specific test according to ISO/IEC 17025.

<sup>13</sup> A summary of tests and requirements for powder coatings is given in [Appendix A10](#).



- Dry adhesion ([2.4.1](#))
- Indentation ([2.5](#))
- Cupping test ([2.6](#))
- Bend test ([2.7](#))
- Impact test ([2.8](#))
- Resistance to humid atmospheres ([2.9](#))
- Acetic acid salt spray resistance ([2.10](#))
- Accelerated weathering test ([2.12](#))
- Polymerisation test ([2.14](#))
- Resistance to mortar ([2.15](#))
- Wet adhesion ([2.4.2](#))
- Condensation water test ([2.16](#))
- Water spot test ([2.19](#))
- Scratch and mar resistance test Martindale ([2.20](#))
- Natural weathering (Florida) ([2.13](#))

These tests shall be made on three test panels (for mechanical tests) and on three test samples (for corrosion tests) coated by a laboratory approved by QUALICOAT.

Exceptions are the Martindale and water spot tests, which shall each be carried out on one panel, and the accelerated weathering test, which shall be carried out on the number of test panels specified in the corresponding section [2.12](#) according to the specific case.

#### 4.1.4 Basic colours to be tested for standard approvals and metallic extension

##### 4.1.4.1 Standards approvals

###### Classes 1, 1.5 and 2

The following colours shall be tested (independently of gloss category or appearance):

- white RAL 9010
- blue RAL 5010
- red RAL 3005

###### Class 3

The following RAL colours shall be tested:

- Lightness category LIGHT
  - RAL 1015
  - RAL 7035
  - RAL 9010
- Lightness category MEDIUM
  - RAL 1011
  - RAL 7040
  - RAL 8024
- Lightness category DARK
  - RAL 7016
  - RAL 8019
  - RAL 9005

#### 4.1.4.2 Metallic extension

For classes 1, 1.5 and 2; if a manufacturer wishes to have an approval extended for metallic colours, tests shall be carried out on RAL 9006.

For class 3; if a manufacturer wishes to have an approval extended for metallic colours, tests shall be carried out on RAL 9006. If satisfactory, the extension shall be granted to all lightness categories related to the same gloss category.

#### 4.1.5 Basic colours to be tested for special approvals

##### 4.1.5.1 Special approvals valid for single colours

If a coating material is produced for a single colour, tests shall be carried out only on the colour mentioned in the system name. The tests are the same as those specified in § 4.1.3.

No other colours shall be produced under the same approval number.

#### 4.1.6 Sampling

The manufacturer shall send coating materials and coated samples to the laboratory in charge, together with the relevant technical data sheet for each colour. The data sheet shall include at least the following information: colour, gloss value and curing conditions (including range of times and temperatures).

The testing laboratory shall prepare the test samples on its premises using chrome VI-free chemical pretreatment and the coating materials supplied by the manufacturer. The test samples may also be coated elsewhere provided that the inspector is present during the whole time of treatment.

The testing laboratory shall always select the minimum stoving time and temperature specified by the manufacturer. After checking the colour and gloss, the laboratory shall perform the above-mentioned tests on the samples.

#### 4.1.7 Assessment of test results

The testing laboratory shall submit the test report to the General Licensee or to QUALICOAT in countries where there is no General Licensee.

The inspection reports shall be assessed by the General Licensee. Under the supervision of QUALICOAT, the General Licensee shall decide whether or not to grant an approval or an extension.

- If the results of all tests (excluding the natural weathering test) meet the requirements for all basic colours an approval or extension shall be granted.
- If the results of all tests (excluding the natural weathering test) meet the requirements for the basic colours but not for the metallic one, an approval shall be granted for all colours excluding metallic ones.
- If the results of any of the tests (excluding the natural weathering test) on a basic colour do not meet the requirements, the manufacturer of the organic coating material tested shall be informed that no approval or extension can be granted for the time being, stating the details and reasons.
- If the results of all tests (excluding the natural weathering test) are satisfactory for the metallic colour but not for the basic colours, the manufacturer of the organic





coating material tested shall be informed that no approval can be granted for the time being, stating the details and reasons.

The approval shall be confirmed if the results of the natural weathering test in Florida are satisfactory for all basic colours.

If the result is unsatisfactory for the metallic colour alone, the approval shall be maintained for all colours except metallic ones.

In all other cases, the approval shall be withdrawn at the end of the year, but the single failed basic colour shall already be banned by the end of September.

QUALICOAT shall publish the Florida test results including the deadlines on [www.qualicoat.net](http://www.qualicoat.net) at the end of August.

Within 30 working days after receiving the Florida test results from QUALICOAT, the General Licensee shall inform the powder manufacturer of the unsatisfactory result and of the resulting ban of the failed colour.

The table below shows the different deadlines until when the powder manufacturer may still produce and sell the different colours and until when a licensee may use them.

DEADLINES					
Production of QUALICOAT approved products		Sale of QUALICOAT approved products		Use of QUALICOAT approved products by licensee	
Single failed basic colour	Remaining colours	Single failed basic colour	Remaining colours	Single failed basic colour	Remaining colours
30.09.xx	31.12.xx	30.03.yy	30.03.yy	End of original shelf life	

xx = current year    yy = following year

#### 4.1.8 Inspection of coating manufacturer’s plant

A visit shall be required before granting an approval to new applicants in order to check the laboratory equipment of the coating manufacturer’s plant. The costs of such a visit will be paid by the applicant. If a visit is considered unsatisfactory, the General Licensee (or QUALICOAT) retains the right not to grant the approval.

### 4.2 Renewal of an approval

After an approval has been granted to a coating material, laboratory tests and Florida exposure shall be performed annually, and an inspection of the coating manufacturer’s plant shall be carried out every three years.

#### 4.2.1 Laboratory tests and Florida exposure

##### 4.2.1.1 Renewal of class 1 and class 1.5 approvals

Consistent quality of approved organic coating materials is monitored with all the tests listed in § 4.1.3 being performed on two colours chosen from the three colours specified by QUALICOAT each year. One metallic colour specified by QUALICOAT (RAL 9006 and RAL 9007 alternately) shall also be tested every year if there is an extension for metallic colours.



#### 4.2.1.2 Renewal of class 2 and class 3 approvals

Consistent quality of approved systems is monitored annually with all the tests listed in § 4.1.3 being performed on two colours chosen from the three colours of the same RAL family<sup>14</sup> specified by QUALICOAT each year, excluding critical RAL colours<sup>15</sup>.

If a powder supplier himself considers a colour or a family specified by QUALICOAT to be critical, he shall inform QUALICOAT and this information will be mentioned on the approval certificate and published on the QUALICOAT website. QUALICOAT will specify an alternative colour or family for the renewal.

One metallic colour specified by QUALICOAT (RAL 9006 and RAL 9007 alternately) shall also be tested every year if there is an extension for metallic colours.

#### 4.2.1.3 Renewal of special approvals

For renewals of special approvals, the same colours as for granting an approval shall be tested in a laboratory and in Florida every year.

### 4.2.2 Sampling

There are three options for sampling systems to be tested for renewal of approvals:

- The inspector takes samples of the required colours during routine inspections at the coaters' production sites.
- The inspector takes samples directly at the system manufacturer's premises.
- The powder manufacturer sends data sheet for each colour. The data sheet shall include at least the following information: colour, gloss value and curing conditions (including range of times and temperatures). In countries where there is neither a General Licensee nor a testing laboratory, the coating organic coating materials and coated panels to the laboratory in charge expeditiously, from 1 January and not later than 31 May of the current year, together with the relevant technical manufacturer sends the selected colours to a laboratory approved by QUALICOAT.

The coating material may be applied to the test panels in the testing laboratory, at a local licensed coater's production site or at the coating manufacturer's premises under the auspices of the inspector according to § 4.1.6.

### 4.2.3 Assessment of laboratory test results

The testing laboratory shall submit the test report via the web interface. QUALICOAT shall assess the results and decide whether to renew or withdraw the approval or to ban colours as follows:

- If the results of any of the laboratory test(s) do not meet the requirements for a colour, all the laboratory tests shall be repeated for this particular colour within one month, using new samples.
- If the results of this second series of tests are again unsatisfactory, the colour shall be banned.

---

<sup>14</sup> For a definition and list of RAL families, see [Appendix A11](#).

<sup>15</sup> For a definition and list of critical colours, see [Appendix A11](#).



Within 10 working days after receiving the laboratory test results from QUALICOAT, the General Licensee shall inform the powder manufacturer of all the results and their consequences (e.g. request for repetition or ban of a colour).

**4.2.4 Assessment of the Florida test results**

The Florida Working Group shall submit the test results to QUALICOAT.

For all classes

- The approval shall be renewed if the result of the natural weathering test in Florida is satisfactory.
- If the result is unsatisfactory for one colour, the colour shall be banned.

Additional rules for classes 2 and 3

- If the colour change result is unsatisfactory for two colours of the same RAL family, the RAL family shall be banned.
- If the gloss retention result is unsatisfactory for two colours of the same RAL family, only those two colours shall be banned.

If a powder manufacturer has failed for any reason to submit the required colours to the laboratory on time and if no samples were sent to Florida as a result, two renewal colours specified by the Florida Working Group and one metallic colour (if there is an extension to metallic colours) shall be banned.

**4.2.5 Banned colours**

QUALICOAT shall publish on [www.qualicoat.net](http://www.qualicoat.net) the colours currently banned according to § 4.2.4, including colours suspended according to § 4.2.6, for every approved organic coating P-No. by the end of August.

Within 30 working days after receiving the Florida test results from QUALICOAT, the General Licensee shall inform the powder manufacturer of the unsatisfactory result and of the resulting ban of the failed colour.

The powder manufacturer shall have the banned colour tested again by sending organic materials and coated panels to the testing laboratory before the end of May of the following year. To have the Florida exposure started the following year, the powder manufacturer shall send the banned colours to the testing laboratory before the end of November of the current year.

Banned colours shall not be used under QUALICOAT’s approval.

The tables below show the different deadlines until when the powder manufacturer may still produce and sell a single failed colour or a banned colour family and until when a licensee may use it.

For all classes

DEADLINES					
Production of QUALICOAT approved products		Sale of QUALICOAT approved products		Use of QUALICOAT approved products by licensee	
Single failed colour	Remaining colours	Single failed colour	Remaining colours	Single failed colour	Remaining colours
30.09.xx	----	30.03.yy	---	End of original shelf life	---

xx = current year    yy = following year



For a class 2 or 3 banned colour family

DEADLINES					
Production of QUALICOAT approved products		Sale of QUALICOAT approved products		Use of QUALICOAT approved products by licensee	
Single failed colour	Remaining colours of the banned family	Single failed colour	Remaining colours of the banned family	Single failed colour	Remaining colours of the banned family
30.09.xx	31.12.xx	30.03.yy	30.03.yy	End of original shelf life	

xx = current year    yy = following year

**4.2.6 Suspended colours**

A colour shall have the status “suspended” in case of:

- an unsatisfactory accelerated weathering test, with samples sent to Florida for the natural weathering test
- satisfactory results of the laboratory tests on a banned colour, with samples sent to Florida for the natural weathering test.

Like banned colours, suspended colours shall not be used under QUALICOAT’s approval. However, they shall not be considered when counting colours for the withdrawal of an approval.

Suspended colours shall be indicated with an asterisk in the list of approved powder coatings published on [www.qualicoat.net](http://www.qualicoat.net).

The number of suspended colours and the duration of the suspension shall be limited as follows:

	Number of suspended colours allowed by P-No.	Maximum duration of suspension
<b>Class 1</b>	Maximum 2	Two years
<b>Class 1.5</b>	Maximum 3	Three years
<b>Class 2</b>	Maximum 4	Four years
<b>Class 3</b>	Maximum 8	Ten years

If these limits are exceeded, the colours concerned shall be banned.

Suspended colours that meet the requirements after the full natural weathering test period shall have their suspension lifted after the Florida Working Group’s meeting.

Suspended colours that fail again in the Florida test shall be banned.

**4.2.7 Withdrawal of an approval or extension**

**4.2.7.1 Withdrawal by QUALICOAT**

Classes 1 and 1.5

The approval shall be withdrawn as soon as four non-metallic colours are banned. In applying this rule suspended colours will not be considered.



**Classes 2 and 3**

The approval shall be withdrawn as soon as one of the following conditions is met:

- two RAL families are banned; or
- four solid, i.e. non-metallic, colours belonging to at least two different RAL families are banned.

**For all classes**

- The extension for metallic colours shall be withdrawn as soon as both RAL 9006 and RAL 9007 are banned.
- A special approval valid for a single colour shall be withdrawn as soon as this single colour is banned.
- The approval shall be withdrawn at the end of the year, but a single failed colour shall already be banned by the end of September.
- QUALICOAT shall publish the Florida test results including the deadlines on [www.qualicoat.net](http://www.qualicoat.net) at the end of August.

The table below shows the different deadlines until when the powder manufacturer may still produce and sell a single failed colour and until when a licensee may use it.

DEADLINES					
Production of QUALICOAT approved products		Sale of QUALICOAT approved products		Use of QUALICOAT approved products by licensee	
Single failed colour	Remaining colours	Single failed colour	Remaining colours	Single failed colour	Remaining colours
30.09.xx	31.12.xx	30.03.yy	30.03.yy	End of original shelf life	

**4.2.7.2 Voluntary withdrawal**

In case of voluntary withdrawal of approval by a powder manufacturer, the following administrative procedure will be followed:

Withdrawal request	ADMINISTRATION
January – March XX	<ul style="list-style-type: none"> <li>• Date of cancellation: 31.03.XX</li> <li>• No approval fees will be charged for year XX</li> <li>• Any panels still remaining on the Florida exposure field will be removed.</li> </ul>
April – December XX	<ul style="list-style-type: none"> <li>• Date of cancellation: 31.12.XX</li> <li>• Full approval fees will have to be paid for year XX</li> <li>• Florida test results assessed by the Florida WG in the summer YY will be communicated to powder manufacturer.</li> </ul>

The table below depicts the different deadlines that determine until when a powder manufacturer may still produce and sell a withdrawn product, and until when a licensee may use it:

Withdrawal request	Deadline for stopping production	Deadline for stopping sale	Use of product by licensee
January – December XX	Date of withdrawal request	30.03.YY	End of original shelf life



#### **4.2.8 Procedure for unbanning colour families for class 2**

If a family is banned, the two banned colours plus the third colour selected for that family in the relevant renewal period shall be tested.

- If all three colours are satisfactory, the family shall be unbanned.
- If two colours are satisfactory and one colour is unsatisfactory, the family shall be unbanned, but the unsatisfactory colour shall remain banned.
- If two or three colours are unsatisfactory, the family shall remain banned.

#### **4.3 Powder manufacturer's right of appeal**

The powder manufacturer shall receive a copy of each test and inspection report. If the results do not meet the requirements, full details and reasons shall be given.

The powder manufacturer shall be entitled to appeal to the General Licensee, or to QUALICOAT in countries where there is no General Licensee, within 10 working days after receiving notification of the Florida test results from the GL or from QUALICOAT in countries where there is no General Licensee.

#### **4.4 Use of the logo by coating manufacturers**

The use of the logo shall comply with the Regulations for use of the QUALICOAT quality label ([Appendix A1](#)).



# Chapter 5

## Licensing of Coaters' Production Sites

## 5 Licensing of Coaters' Production Sites

This chapter specifies the procedure for granting a licence to a coater for one production site.

The procedures for granting and renewing a licence to coaters applying decoration are set out in a separate document available on the [QUALICOAT Website](#).

The procedures for granting and renewing an endorsement to coaters, who produce coated cold-rolled aluminium material suitable for postforming, are set out in [Appendix A14](#).

### General data on production site

Prior to the first inspection in the granting process, the applicant shall fill in the form '*General Data of Licensee*' providing detailed information about the production site that the licence is being applied for. The applicant shall submit the form to the General Licensee, or to QUALICOAT in countries without GL.

The same obligation applies to licensees, who shall fill out the form and submit it as described above by the end of each calendar year. Having received such information, the General Licensee shall forward this document to QUALICOAT. The General Licensee, or QUALICOAT in countries without GL, shall forward the information about the production site to the inspector, and to the testing institute commissioned with carrying out the inspections.

The licensee shall mark all coating lines used for the coating of aluminium for architectural applications with their respective designation as listed in the form '*General Data of Licensee*' so that the lines are clearly identifiable for the inspector.

The licensee shall immediately inform the General Licensee (respectively QUALICOAT in countries where there is no General Licensee) about any changes relevant for the '*General Data of Licensees*', e.g., in the event that a coating line is no longer used for coating of aluminium for architectural applications or if an additional coating line is used for coating of aluminium for architectural applications.

### 5.1 Granting of a licence (quality label)

A preliminary inspection can be requested by the applicant but in this case the results cannot be used for granting the licence.

Every coating line as defined in these Specifications shall be inspected in order for a QUALICOAT licence to be granted.

Two inspections shall be satisfactory before a licence is granted. These inspections will be made at the coater's request.

The first inspection will be conducted by appointment.

The second will be unannounced and will only take place within maximum six months once all the results of the first inspection (including the acetic acid salt spray resistance test) have been found satisfactory.

The inspectors shall take along the following equipment:

- Thickness meter
- Conductivity meter
- Calibration tools for the other tests stipulated





### 5.1.1 Verification of the data concerning the coating lines

The inspector shall verify the plausibility of the data provided by the applicant regarding the coating lines operated at the production site and their use for coatings on aluminium for architectural applications. He shall produce a separate inspection report for each coating line inspected and shall indicate the designation of the respective coating line as marked on site.

The inspector shall visually check what kind of parts are produced on the coating lines, especially on those that are not listed for inspection. If these lines produce coatings on typical architectural products like extrusions or sheets, the inspector shall ask for an explanation why these products are not to be considered architectural. If no sufficient explanation can be given by the coater, the inspector shall make a remark in the inspection report.

The inspector shall check the following using the inspection form approved by QUALICOAT.

### 5.1.2 Inspection of materials

The inspector will check that for outside architectural applications the coater uses organic coating materials approved by QUALICOAT. If chemical materials other than the chromate conversion coating described in § 3.3.1 are used, he shall also check that these chemical materials are approved by QUALICOAT.

### 5.1.3 Inspection of laboratory equipment

As specified in § 3.8 to ensure that the equipment is available, functional and properly used. The inspector will also verify whether there are relevant standards or written operating instructions according to § 3.10.

### 5.1.4 Inspection of production process and equipment

According to § 3.1, 3.6 and 3.7.

### 5.1.5 Inspection of chemical pretreatment

According to § 3.2, 3.3, 3.4 or 3.5

### 5.1.6 Inspection of finished products

Only finished products which have been released by the coater are to be tested (all parts ready for dispatch are deemed to have been released by the coater).

The number of pieces on which film thickness measurements (see § 2.3) shall be made is shown in the table below (subject to a minimum of 30 pieces).

Lot size (')	Number of pieces (random selection)	Acceptance limit for rejected pieces
1 - 10	All	0
11 - 200	10	1
201 - 300	15	1
301 - 500	20	2
501 - 800	30	3
801 - 1'300	40	3
1'301 - 3'200	55	4
3'201 - 8'000	75	6
8'001 - 22'000	115	8
22'001 - 110'000	150	11



(') Lot: 1 lot represents a customer's complete order in one colour or that part of the order which is in the production site.

The inspector shall perform the following tests on the finished products:

- Appearance (to test the uniformity of production) ([2.1](#))
- Thickness ([2.3](#))
- Dry adhesion ([2.4.1](#)) and wet adhesion ([2.4.2](#))
- Acetic acid salt spray ([2.10](#))
- Machu ([2.11](#))
- Polymerisation ([2.14](#))
- Sawing ([2.17](#))

During the first inspection, the Machu test is carried out prior to the acetic acid salt spray test. If the result of the Machu test is satisfactory, the acetic acid salt spray test will then be performed. However, if the result of the Machu test is unsatisfactory, the first inspection will be considered unsatisfactory and shall be repeated. The inspection is satisfactory when all tests are satisfactory including the acetic acid salt spray test.

In the second inspection, only the Machu test will be carried out. If the result of the Machu test is unsatisfactory, the second inspection shall be repeated.

#### 5.1.7 Inspection of the test panels

The following tests shall be performed on test panels processed concurrently with a production lot:

- Gloss ([2.2](#))
- Thickness ([2.3](#))
- Dry adhesion ([2.4.1](#))
- Bend ([2.7](#))
- Impact ([2.8](#))

#### 5.1.8 Review of in-house control and registers

The inspector will check that in-house control has been carried out in accordance with § [3.9](#) and that the coater maintains registers according to § [3.11](#).

In the in-house control register he will check that the results recorded in the register coincide with the results of the test panels. For this reason, all test panels shall be kept and held at the inspector's disposal for one year.

#### 5.1.9 Final assessment for granting the licence

The inspector submits the inspection reports to the General Licensee for the evaluation.

Under the supervision of QUALICOAT, the procedure below is to be followed by the General Licensee:

- If the results of both inspections meet the requirements, a licence to use the quality label shall be granted.
- If the results of one of the two inspections do not meet the requirements, the coater will be informed that the licence to use the quality label cannot be granted for the time being, stating reasons. The coater shall wait at least three months before making a new application for a licence.



### 5.1.10 SEASIDE endorsement

If the coater has applied for the endorsement SEASIDE an inspection shall be carried out following the specifications as set out in § [3.2.1](#), and filiform corrosion test(s) shall be carried out on finished products (§ [2.18](#)) with every type of pretreatment the coater wishes to use for SEASIDE.

If the results of the inspection meet the requirements, the SEASIDE endorsement shall be granted. A specific QUALICOAT SEASIDE certificate shall be issued<sup>16</sup> stating that the licensee is able to produce finished products that meet the SEASIDE requirements.

If the results of the inspection do not meet the requirements, the coater shall wait at least three months before making a new application for a SEASIDE endorsement.

### 5.1.11 SEASIDE (PRE-OX) endorsement

A SEASIDE (PRE-OX) endorsement can be granted by QUALICOAT either to coaters using in-house anodic pretreatment or to coaters using off-site pre-anodised products.

If the coater has applied for the SEASIDE (PRE-OX) endorsement, an inspection shall be carried out following the specifications as set out in § [3.4.](#), and in the case of off-site anodic pretreatment in [Appendix A15](#). A filiform corrosion test shall be conducted on finished products (§ [2.18](#)) in addition to the tests listed in § [5.1.6](#).

If the results of the inspection meet the requirements, the SEASIDE (PRE-OX) endorsement shall be granted for the coating line inspected.

If the results of the inspection do not meet the requirements, the coater shall wait at least three months before making a new application for a SEASIDE (PRE-OX) endorsement.

## 5.2 Routine inspections of licensees

After a coater has been granted a licence to use the quality label, this licence shall be renewed if the results of at least two inspections per year meet the requirements.

Every coating line shall be inspected twice a year in order for a QUALICOAT licence to be renewed.

Routine inspections shall be made without prior notice. Inspectors will only be authorised by the GL or QUALICOAT Secretariat to announce an inspection in the case of travel safety issues or visa problems.

Licensees shall immediately inform the General Licensee, or QUALICOAT in countries without GL, in case a coating line is out of operation, regardless of whether planned or due to a technical failure.

### 5.2.1 Verification of the data concerning the coating lines

The inspector shall verify the plausibility of the data provided by the licensee regarding the coating lines operated at the production site and their use for coatings on aluminium for architectural applications.

He shall produce a **separate inspection report for each coating line inspected** and indicate the designation of the respective coating line as marked on site.

The inspector shall visually check what kind of parts are produced on the coating lines, especially on those coating lines that are not listed for inspection.

<sup>16</sup> For the use of the QUALICOAT SEASIDE logo, see [Appendix A1](#), § 5 and § 6



In case these lines produce coatings on typical architectural products like extrusions or sheets, the inspector shall ask for an explanation why these products are not to be considered architectural. If no sufficient explanation can be given by the coater, the inspector shall make a remark in the inspection report.

## 5.2.2 Inspectors' equipment and checklists

The inspectors shall take along the following equipment:

- Thickness meter
- Conductivity
- Calibration tools for the other tests stipulated

The inspector shall check the following using the inspection form approved by QUALICOAT:

- an inspection of materials according to § [5.1.2](#)
- an inspection of laboratory equipment according to § [5.1.3](#)
- an inspection of production process and equipment according to § [5.1.4](#)
- an inspection of chemical pretreatment according to § [5.1.5](#)
- an inspection of finished products and test panels according to § [5.1.6](#) and § [5.1.7](#)
- an acetic acid salt spray test to be carried out on samples taken during the first inspection according to § [2.10](#)
- a review of the registers according to § [5.1.8](#)
- attendance in training

As the training is mandatory the inspector shall check that at least one in-house control employee and/or one responsible quality employee have attended regularly trainings organised at least once every two years by the General Licensees or by QUALICOAT in countries without GL.

In case of non-compliance with this requirement the inspector shall make a remark in the inspection report and, in case of repetition of this non-compliance after the next organised training has taken place, a non-conformity shall be issued.

## 5.2.3 Corrosion tests

### 5.2.3.1 Machu test

During the first inspection of the year, the Machu test is carried out prior to the acetic acid salt spray test.

If the result of the Machu test is satisfactory, the acetic acid salt spray test will then be performed. However, if the result of the Machu test is unsatisfactory, the first inspection will be considered unsatisfactory and shall be repeated.

The inspection is satisfactory when all tests are satisfactory including the acetic acid salt spray test.

In the second inspection of the year, only the Machu test will be carried out. If the result of the Machu test is unsatisfactory, the second inspection shall be repeated.



### 5.2.3.2 Acetic salt spray test and Filiform corrosion test

Samples for the acetic salt spray test and the filiform corrosion test (in the case of SEASIDE) shall be taken during the first inspection of the year.

### 5.2.3.3 Special cases

#### Unforeseen problems during renewal inspections

In cases of unforeseen problems arising at short notice, or in the case that a pretreatment cycle is not in use on the day of the inspection when AASS, FFC, and/or Machu test samples are to be taken, the following rule shall apply:

- The inspector shall fill in the inspection report on the basis of the documentation of the in-house control and shall take the samples for corrosion tests from finished products.
- If such samples are not available on the day of the inspection, the licensee shall send these samples to the testing institute within one month from the inspection date.
- If the licensee fails to do so, the inspection shall be evaluated as 'not satisfactory'.

#### Anodic pretreatment

For lines where parts with chemical conversion as well as parts with anodic pretreatment are coated, the following rule shall apply:

- During the first inspection of the year, samples for the acetic acid salt spray test and the filiform corrosion test (if the licensee uses chemical conversion for SEASIDE as well) shall be taken on parts with chemical conversion and a separate report shall be filled in.
- Also during the first inspection of the year, samples for the acetic acid salt spray test and the filiform corrosion test shall be taken on parts with anodic pretreatment and a separate report shall be filled in.
- During the second inspection of the year, also two reports will be filled in but the samples shall only be taken from the pretreatment that is in use on the day of the inspection.

The inspector shall submit the inspection reports to the General Licensee for the evaluation.

### 5.2.4 Final assessment for renewing the licence

Under the supervision of QUALICOAT, the procedure below is to be followed by the General Licensee:

- If the results of the inspection meet the requirements, authorisation to use the quality label will continue.
- If the results of the inspection do not meet the requirements another inspection shall be made within one month (allowing for holiday periods) after the coater has received notification of an unsatisfactory inspection from the General Licensee and/or QUALICOAT. In the meantime, the licensee should rectify non-conformities and inform the General Licensee or QUALICOAT immediately.



If the second inspection again produces unsatisfactory results, the licence to use the quality label will be withdrawn immediately. The coater shall wait at least three months before making a new application for a licence to use the quality label.

#### **5.2.5 Licences with SEASIDE endorsement**

Routine SEASIDE inspections are carried out as set out in § [3.2.1](#) during QUALICOAT inspections and a filiform corrosion test is performed on finished products (§ [2.18](#)) during the first inspection of the year, in addition to the tests listed in § [5.1.6](#).

At least one SEASIDE inspection shall be possible and satisfactory during the year. If no SEASIDE inspection is possible during QUALICOAT visits, an additional announced inspection shall be carried out.

If the results of the inspection meet the requirements, the SEASIDE endorsement shall be confirmed.

If the result of the FFC test is D, another complete and unannounced inspection including SEASIDE shall be conducted.

If the second inspection again produces unsatisfactory results, the SEASIDE endorsement shall be withdrawn immediately. The coater shall wait at least three months before making a new application for a SEASIDE endorsement.

#### **5.2.6 Licences with (PRE-OX) endorsement**

Routine SEASIDE (PRE-OX) inspections are carried out as set out in § [3.4](#) and in [Appendix A15](#) if applicable during QUALICOAT inspections, and a filiform corrosion test is performed on finished products (§ [2.18](#)) in addition to the tests listed in § [5.1.6](#) during the first inspection of the year.

For lines where parts with chemical conversion as well as parts with anodic pretreatment are coated, the rules stated in the introduction of section § [5.2](#) apply.

If a coating line is equipped to only produce pre-anodising, then two annual inspections based on pre-anodising shall be conducted.

If the inspection results meet the requirements, SEASIDE (PRE-OX) endorsement shall be confirmed.

If the FFC test result is D, another complete inspection, including SEASIDE (PRE-OX), shall be conducted.

If the repeat inspection produces unsatisfactory results, the SEASIDE (PRE-OX) endorsement shall be withdrawn immediately. The coater shall wait for at least three months before making a new application for a SEASIDE (PRE-OX) endorsement

#### **5.2.7 Suspension of an inspection**

In case of political unrest or unforeseen circumstances and after consultation with the testing laboratory responsible the inspection can be suspended for a maximum period of 12 months by the General Licensee or by QUALICOAT. After this period, the licence will be cancelled.



### **5.3 Licensee's right of appeal**

The licensee shall receive a copy of each inspection report. If the results do not meet the requirements, full details and reasons shall be given. The licensee shall be entitled to appeal within 10 days.

### **5.4 Confidentiality of information**

All information concerning the inspection results and their assessment shall be confidential.

### **5.5 Deadlines for submission of inspection reports**

All inspection reports (including test results) shall reach QUALICOAT's Secretariat within three months of the dates of the inspections.

If a production site inspection was unsatisfactory, the General Licensees shall send the report to QUALICOAT's Secretariat within one month after the inspection.

### **5.6 Use of the logo by licensees**

The use of the logo shall comply with the Regulations for use of the QUALICOAT quality label ([Appendix A1](#)).

### **5.7 Training of licensees**

Training for staff of licensed production sites is mandatory in all countries. This training shall be organised regularly by the General Licensees or QUALICOAT.



# Chapter 6

## Specifications for In-House Control



## 6 Specifications for In-House Control

The aim of in-house control is to give the licensee a tool to keep control over its own production process. The number of shifts worked, the requirements, the results of the analyses and corrective actions shall be entered in charts or some other records/registration systems readily accessible to the inspector.

The staff responsible for managing in-house control shall follow the training programme stipulated by QUALICOAT.

### 6.1 Controlling the production process parameters

#### 6.1.1 Chemical pretreatment baths

The chemical parameters defined by the manufacturer of the chemical pretreatment materials shall be analysed at least once per bath in every working shift, or according to the chemical supplier's advice, that shall be at least once per day (24 hours).

#### 6.1.2 Water quality

The conductivity of the final rinsing preceding chromate bath and of the demineralised rinsing water shall be measured at least once per bath in every working shift, or according to the chemical supplier's advice, that shall be at least once per day (24 hours).

#### 6.1.3 Measuring the temperature of chemical pretreatment and rinsing baths

The temperature of the pretreatment baths and the final rinse, if a hot water rinse, shall be measured at least once per bath in every working shift, or according to the chemical supplier's advice, that shall be at least once per day (24 hours).

#### 6.1.4 Recording and measuring the drying temperature

The drying temperature displayed shall be recorded at least once in every working shift.

The temperature shall be measured on parts at least once a week using a recording instrument or some other means such as thermochromic pencils or tablets.

#### 6.1.5 Measuring the stoving conditions

The stoving conditions according to § [3.7](#) shall be tested as follows:

- The displayed temperature shall be recorded at least once in every working shift.
- A stoving curve shall be made on profiles at least twice a week.

### 6.2 Quality control of the chemical pretreatment

#### 6.2.1 Testing the etching degree

The degree of aluminium removal shall be measured at least once in every working shift, or according to the chemical supplier's advice, that shall be at least once per day (24 hours). using the method described in § [3.2.1](#).



If a licence has the SEASIDE endorsement, the licensee shall check the etching degree at least once in every working shift during SEASIDE production.

### 6.2.2 Testing the weight of the conversion coating

The weight of chromate conversion coating shall be tested in accordance with EN 12487 at least once in every working shift, or according to the chemical supplier's advice, that shall be at least once per day (24 hours).

## 6.3 Quality control of the finished products

### 6.3.1 Gloss test (ISO 2813)

The gloss of the organic coating on finished products shall be tested at least once in every working shift for each colour shade and each manufacturer.

### 6.3.2 Coating thickness test (ISO 2360)

The coating thickness shall be measured on pieces as specified below:

Lot size (')	Number of pieces (random selection)	Acceptance limit for rejected pieces
1 - 10	All	0
11 - 200	10	1
201 - 300	15	1
301 - 500	20	2
501 - 800	30	3
801 - 1'300	40	3
1'301 - 3'200	55	4
3'201 - 8'000	75	6
8'001 - 22'000	115	8
22'001 - 110'000	150	11

\* lot : a customer's complete order in one colour or the part of the order that has already been coated.

### 6.3.3 Appearance test

The appearance shall be controlled on pieces as specified below:

Lot size (')	Number of pieces (random selection)	Acceptance limit for rejected pieces
1 - 10	All	0
11 - 200	10	0
201 - 300	15	0
301 - 500	20	0
501 - 800	30	0
801 - 1'300	40	0
1'301 - 3'200	55	0
3'201 - 8'000	75	0
8'001 - 22'000	115	0
22'001 - 110'000	150	0

\* lot : a customer's complete order in one colour or the part of the order that has already been coated



#### 6.3.4 Adhesion test

##### Dry adhesion (ISO 2409)

The dry adhesion test shall be carried out at least on one panel for every two production hours<sup>17</sup>.

##### Wet adhesion

The wet adhesion test shall be carried out on finished products at least once in every working shift. All samples from one working day may be tested together.

#### 6.3.5 Polymerisation test

This test is used to check that the organic coating polymerisation is good. In in-house control, this test is **optional for powder coatings**.

The polymerisation test shall be carried out on test panels at least once in every working shift for each colour shade and gloss category and for each manufacturer.

#### 6.3.6 Bend test (ISO 1519)

The resistance to cracking on bending shall be tested at least on one panel for every two production hours<sup>17</sup>.

#### 6.3.7 Impact test (ISO 6272 / ASTM D 2794)

The impact test shall be carried out on test panels at least on one panel for every two production hours<sup>17</sup>.

### 6.4 Quality control registers

#### 6.4.1 Control register for the production process

This control register is either a bound register with numbered pages, or a computer listing.

It shall show the following information:

- the temperature of the baths,
- the chemical parameters specified by the manufacturers,
- the results of the etching degree test,
- the results of the tests of the conversion coating weight,
- the results of the water conductivity tests,
- the results of the tests of the drying and stoving conditions.
- the drying and stoving temperature curves

#### 6.4.2 Control register for test panels

This control register is either a bound register (not a spiral binding) with numbered pages, or a computer listing.

---

<sup>17</sup> The same panel to be chosen for dry adhesion test, bend test and impact test.



It shall show the following information:

- the production date
- the references of the organic coating material used: RAL or some other reference for identification, lot number, manufacturer's name
- the following results:
  - dry adhesion test
  - polymerisation test (optional for powder coatings)
  - bend test
  - impact test

#### **6.4.3 Control register for finished products**

It is either a bound register (not a spiral binding) with numbered pages, or a computer listing.

It shall show the following information

- the customer's name and the order or lot identification data
- the production date
- the reference of the organic coating material used
- the following results:
  - coating thickness test (minimum and maximum values)
  - inspection of the colour shade and its gloss
  - appearance
  - wet adhesion test

#### **6.4.4 Control register for tests carried out by the chemical manufacturer**

This is either a bound register (not a spiral binding) with numbered pages, or a computer listing.

It shall show the following information

- sample reference
- date of sampling and dispatch/collect
- chemical manufacturer's test report
- test results (see [Appendix A6](#))
- remarks and/or corrective action.



### 6.5 Table summarising the specifications for In-House Control

CONTROL	OBJECT TESTED		FREQUENCY
<b>Process</b> (6.1)	Chemical pretreatment baths, degreasing, pickling, chromating, rinsing	Chemical Parameters	Once per bath in every working shift, or according to the chemical supplier's advice, that shall be at least once per day (24 hours).
	Conductivity of the water		Once per bath in every working shift, or according to the chemical supplier's advice, that shall be at least once per day (24 hours).
	Temperature of chemical pretreatment		Once per bath in every working shift, or according to the chemical supplier's advice, that shall be at least once per day (24 hours).
	Drying temperature		<ul style="list-style-type: none"> <li>Once in every working shift: record the displayed temperature</li> <li>Once a week: make one recording of the temperature using strips or some other means</li> </ul>
	Stoving conditions		<ul style="list-style-type: none"> <li>Once in every working shift: record the displayed temperature</li> <li>Twice a week: make 1 stoving curve on profiles</li> </ul>
<b>Conversion coating</b> (6.2)	Etching degree		Once in every working shift, or according to the chemical supplier's advice, that shall be at least once per day (24 hours).
	Weight of the conversion coating (chromate conversion)		Once in every working shift, or according to the chemical supplier's advice, that shall be at least once per day (24 hours).
	Weight of the conversion coating (chemical pretreatment [chrome VI-free])		Once in every working shift, or according to the chemical supplier's advice, that shall be at least once per day (24 hours).
<b>Finished products</b> (6.3)	Gloss		Once in every working shift for each shade and manufacturer
	Coating thickness		According to the order lot size
	Appearance		According to the order lot size
	Wet adhesion		Once in every working shift <i>All samples from one day may be tested together.</i>
<b>Panels</b> (6.3)	Dry adhesion		Minimum of 1 x sample* for every two production hours.
	Polymerisation (optional for powder coatings)		Once in every working shift for each colour shade and gloss category and for each manufacturer
	Bend test		Minimum of 1 x sample* for every two production hours.
	Impact test		Minimum of 1 x sample* for every two production hours.

\* The same panel to be chosen for dry adhesion test; bend test and impact test



# Appendices



## Appendices

### A1 – Regulations for use of the QUALICOAT quality label for liquid and powder organic coatings on aluminium for architectural applications

#### 1. Definitions

For the purposes of these regulations, the QUALICOAT "Quality Label" denotes the trademark registered by the Association for Quality Control in the Lacquering, Painting and Coating Industry (QUALICOAT), Zurich, with the Federal Patent and Trademark Office on 8 May 1987 under trademark no. 352 316 and in the International Trademark Register on 14 August 1987 under no. 513 227 and published in the Swiss Official Gazette of Commerce on 5 May 1987.

"QUALICOAT" means the Association for Quality Control in the Lacquering, Painting and Coating Industry, Zurich.

"GL" means a General Licensee i.e. a national or an international association holding the QUALICOAT general licence for a defined territory.

"Licence" is a statement issued by or on behalf of the Association authorising the holder to use the Quality Label in accordance with these regulations.

"Approval" is a confirmation that a specific material (coating or chemical conversion) meets the requirements of the Specifications.

"Specifications" are the "Specifications for a Quality Label for liquid and powder organic coatings on Aluminium for Architectural Applications".

"Holder" is the company authorised to use the Quality label.

#### 2. Ownership of the Quality Label

The Quality Label is owned by QUALICOAT and shall not be used by anyone unless authorised to do so by QUALICOAT.

QUALICOAT has granted to the GL a general licence in respect of the Quality Label for ..... (country) with powers to authorise the use of the Quality Label in accordance with these regulations.

#### 3. Qualifications of applicant

Authorisation to use the Quality Label may be granted on condition that the applicant operates in accordance with the Specifications. This authorisation is governed by a contract.

The granting of a licence or approval entitles the Holder to use the Quality Label for the products specified. The licence or approval shall not be transferred.



## 4. Register of holders

QUALICOAT shall keep a register showing (in addition to other details which may be resolved upon now or later) the name, address and trade description of each Holder, the date on which the licence or approval was granted to the Holder, the number assigned to each Holder, the date of withdrawal of the licence or approval and any other details which QUALICOAT may deem necessary.

The Holder shall notify the GL forthwith of any changes in name or address and the GL shall in turn inform QUALICOAT in order for the change to be recorded in the register.

## 5. Use of the logo by coaters and manufacturers

### 5.1 Use in general

The logo exists in black and white, in white and blue (PANTONE Reflex Blue CV; RGB: 14-27-141; CMYK: 100-72-0-6) and in blue and silver (PANTONE Silver 877u; RGB: 205-211-215; CMYK: 8-3-3-9).

The words "Quality Label for Architectural Coating on Aluminium" (or a text appropriate to national legal requirements) may be added in the space to the right.

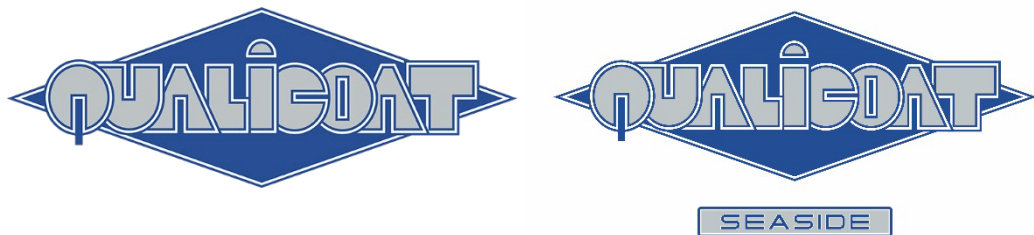

The Holder shall not make any alteration or addition to the logo when using it. In the event that the Holder's own brands or trademarks are used separately on or in connection with his products, these regulations shall not be infringed in any manner whatsoever. Holders of an approval or licence shall at any time provide the GL with all information required as to the use of the logo.

Improper use of the logo may lead to the sanctions stipulated in § 9.

### 5.2 Use of the logo by coaters

Unless explicitly stated otherwise in individual cases, the licensee assures, by using the logo, that the quality of the entirety of coatings on aluminium for architectural applications produced at the licenced production site meets all the requirements of the Specifications.

For licensees that have more than one production site, the quality label shall only be used for the production site for which the licensee is holding the licence.

The logo may be used on the products themselves, business stationery, quotations or invoices, price lists, cards, display boxes and on all company literature and brochures or in catalogues and newspaper advertisements.





Whenever a licensee makes mention or reference to QUALICOAT, it shall systematically indicate its licence number. This shall apply both to the use of the logo and in texts.



Licence n° xxxx

### **5.3 Use of the logo by manufacturers (coating manufacturers and manufacturers of pretreatment systems)**

The QUALICOAT logo shall not appear on packaging or labels.

In their business literature and documents, the coating manufacturers shall only use the logo for products approved by QUALICOAT, stating: «Product approved by QUALICOAT». Wherever the logo is used, the phrase «QUALICOAT is a quality label for licensed coaters» should also appear in the document.

For any other use of the logo, the coating manufacturers are required to submit all new documents mentioning QUALICOAT to their national association. In countries without a General Licensee, these documents shall be submitted directly to the QUALICOAT Secretariat before publication.

## **6. Other conditions for use of the logo**

### **6.1 Use of the logo by General Licensees (national or international associations)**

General Licensees are authorised to use the logo in the stipulated colours but always together with their respective logos or the legal designation of the national or international associations. The logo may also be used in conjunction with a national flag and by adding the name of the country. When the QUALICOAT logo or name is used on licensees' stationery or in correspondence, the national association's name shall always be predominant to avoid any confusion between the licensee and QUALICOAT. Wherever the logo is used, the phrase «X<sup>18</sup> is the QUALICOAT General Licensee for Y<sup>19</sup>» should also appear in the document. The size of the logo may be altered provided that the geometrical proportions are maintained.

### **6.2 Use of the logo by the QUALICOAT Secretariat**

Only the Secretariat is authorised to use the logo without any further designation. The logo should be used in black/white for internal communications, such as circular letters, notices of meetings and minutes. For external use, the stipulated colours are to be used. The logo shall always be placed on the first page of the respective documents, but not necessarily on the following pages. The logo shall be included in the letterhead.

### **6.3 Use of the logo by QUALICOAT officers**

The President of QUALICOAT and the Chairman of the Technical Committee are also authorised to use the logo on business cards prepared by QUALICOAT if such cards are needed for representation purposes. Other members of the Committees (Executive and Technical Committees, Working

---

18 X = name of the national association

19 Y = country



Groups) are neither allowed to use the logo nor to make any reference to QUALICOAT unless authorised to do so by the Executive Committee.

#### **6.4 Use of the logo by interested third parties**

Some businesses using QUALICOAT coated products may wish to use the logo on the products they manufacture or in their business literature.

They shall request written authorisation which may be granted on condition that they:

- undertake to use solely aluminium products coated by licensees;
- undertake to submit all documents that refer to QUALICOAT to the GL for approval or directly to QUALICOAT in countries where there is no GL;
- undertake to undergo inspections and controls by the GL or QUALICOAT.
- Such authorisation may require payment of an annual fee.

### **7. Conditions for granting and renewing approvals and licenses**

As stipulated in [Chapter 4](#) for coating manufacturers.

As stipulated in [Chapter 5](#) for coaters' production sites.

As stipulated in [Appendix A6](#) for manufacturers of chemical pretreatment materials

The granting of an approval or licence shall require payment of an annual fee.

### **8. Withdrawal of approvals and licences**

#### **8.1 Failure to comply with the Regulations**

The GL shall withdraw the approval or licence if the Holder ceases to comply with these regulations and in particular if the Holder is guilty of any improper use of the Quality Label or has failed to pay the annual fee.

In the event of withdrawal of an approval or licence, the Holder shall be given notice in writing by the GL and such notice shall be effective immediately. In such event, all tags, labels, bands, stencils, stamps, wrappers, containers, price lists, business notices, business cards and any other objects in or upon which the Quality Label is affixed shall either be delivered to the GL or, upon the GL's instructions, kept at the disposal of the GL until a new approval or licence is granted.

#### **8.2 Significant changes in a company**

In the case of any significant event (change in shareholders or key personnel, new lines), the company shall notify the GL immediately. The GL shall be authorised to make a supplementary visit in order to ensure that the Holder continues to satisfy all the conditions stipulated in the Specifications.

If the Holder ceases to trade, all tags, labels, bands, stencils, stamps, wrappers, containers, price lists, business notices, business cards and any other objects in or upon which the Quality Label is affixed shall either be delivered to the GL or, upon the GL's instructions, kept at the disposal of the GL until a new approval or licence is granted.



### **8.3 Voluntary withdrawal**

In the event of voluntary withdrawal of an approval or licence, all tags, labels, bands, stencils, stamps, wrappers, containers, price lists, business notices, business cards and any other objects in or upon which the Quality Label is affixed shall either be delivered to the GL or, upon the GL's instructions, kept at the disposal of the GL until a new approval or licence is granted.

### **9. Sanctions**

In the event of improper use of the Quality Label or of any behaviour or action which could impair the image of the Quality Label, the following sanctions may be imposed either by the GL or by QUALICOAT in countries without a GL:

- official statement
- reprimand
- withdrawal of the label

The party concerned shall have the right to appeal first at the GL's level and finally at the QUALICOAT Executive Committee's level whose decision is final.

### **10. Amendments to the Regulations**

These Regulations may be amended if and when necessary. However, the Holder of the label shall be allowed 4 months from the date of publication in which to comply with any such amendment.

### **11. Notices**

Any notice required to be given to or by the Holder under these regulations shall be effective if sent by correctly stamped and addressed letter.



## A2 – List of currently approved procedures<sup>20</sup>

CODE	PROCEDURE	INTENDED FOR
P-EVA	<b>Procedure for evaluating inspection results</b> List of failures to be considered nonconformities	General Licensees
P-FFC	<b>Procedure for the filiform corrosion test</b>	Testing laboratories
P-TAC	<b>Procedure for testing and approving coating materials</b>	Testing laboratories
P-SAMP	<b>Procedure for sampling (coaters' production sites and laboratory tests) - including classification of tests</b>	Testing laboratories

<sup>20</sup> All current procedures are available on request.



## A3 – Compulsory declaration of changes in formulation for organic coating materials approved by QUALICOAT

Organic coating materials essentially consist of 4 kinds of components:

- binder
- pigments
- extenders
- additives

These are the organic coating material's components that determine the organic coating's characteristics.

### 1. BINDER

The binder consists of resin(s) + hardening agent together; it imparts the principal characteristics to the organic coating material (reactivity, application properties, mechanical properties etc.). The main types of resins used in Europe are:

- saturated carboxylated polyester
- saturated hydroxylated polyester
- epoxy
- acrylic

These different types of resins can be used with several different kinds of hardeners.

It is quite obvious that variations in the chemical composition of the different resins or changes in the chemical molecular structure of the hardening agent can bring about modifications in the properties or characteristics of the organic coating and require a new QUALICOAT approval.

### 2. PIGMENTS

Pigments can be organic, inorganic or metallic; they impart colour, appearance and opacity to the organic coating.

### 3. EXTENDERS

Extenders improve the rheological or chemical properties of the organic coating.

### 4. ADDITIVES

These are substances added to the organic coating material in small quantities to improve certain characteristics of the organic coating (vapour relief, gloss etc.).

These other components (pigments, extenders or additives) of organic coating material can also have some influence on the film properties and characteristics controlled within the QUALICOAT label. Nevertheless, as these constituents can be numerous and varied, it is up to the organic coating manufacturers to control their formulations so that they comply with the QUALICOAT label.

### 5. APPEARANCE OF THE FINAL ORGANIC COATING

Like all other coatings, organic coating materials – after curing – can give the final organic coating different appearances, for example a smooth appearance or a structured appearance.

A structured appearance cannot be treated like a smooth appearance. Even if the change in formulation is based on special additives, an organic coating imparting an uneven appearance, which does not involve colour gloss or metallic effect, needs a special QUALICOAT approval in a different category from the approvals granted for smooth organic coatings.

#### Definition criteria for structured finishes

These finishes can be split into the following three types. An approval is necessary for each type (QUALICOAT designation a, b, c).

##### a) Leathered or orange-peel appearance (waves)

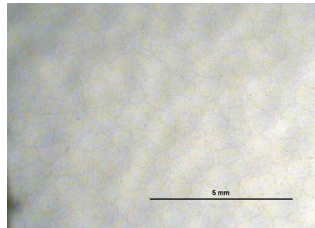

##### b) Textured or sandpaper appearance (sharp edges)



##### c) Wrinkled or vein appearance (heterogeneous)

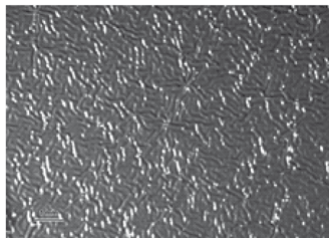



## A4 – Metallic organic coating

### 1. DEFINITION

Metallic organic coating materials are organic coatings with a metallic or metallised effect. A metallic organic coating is a "normal" organic coating, the difference is the pigmentation. Manufacturers achieve this special effect by incorporating metal (for example: leafing or non-leafing aluminium) or other materials (for example: mica) in the formulation of the organic coating.

We can separate metallic organic coatings into two categories:

- One-coat systems with a metallised appearance (no clear coat is needed for good outdoor durability and resistance). **The current approvals are sufficient.**
- Two-coat systems: metallic powder coatings that need a clear coat in order to have acceptable weathering resistance. **These specific two-coat systems shall be approved separately by QUALICOAT.**

*The manufacturers are responsible for advising their customers whether they need to use a two-coat system or not.*

### 2. REFERENCE SCALE



Some metallic colours, especially those based on aluminium, may show variations in colour during tests that affect the surface of the coating. In this case, QUALICOAT accepts a slight variation in colour. In the case of metallic colours, the colour variations may differ depending on the angle of observation. This makes it difficult to perform a reliable measurement using any of the apparatus defined in the standard mentioned in § [2.12](#) of the Specifications.

For this reason, a reference scale for the laboratories has been defined using panels coated in an aluminium-based metallic colour (RAL 9006). The stains are obtained by applying an alkaline solution to the surface for different lengths of time. These different panels produced by an approved laboratory are approved and distributed by QUALICOAT. Each approved laboratory shall have these reference panels.

For information, the following photographs show values 1 and 2 on the reference scale.

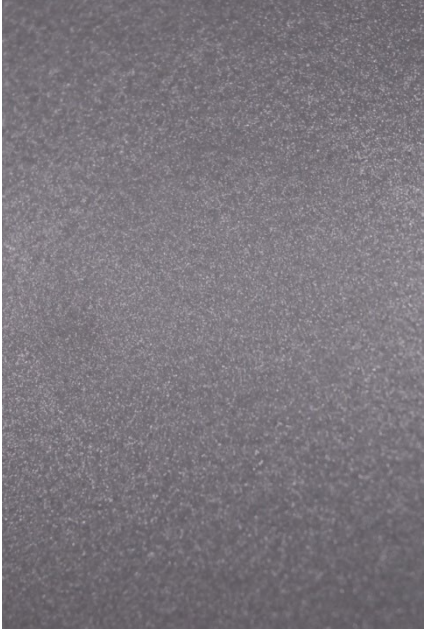

**REFERENCE FOR EVALUATING MORTAR TEST RESULTS**  
(FOR INFORMATION)

 <p>Acceptable value 1</p>	 <p>Acceptable value 1</p>
 <p>Unacceptable value 2</p>	 <p>Unacceptable value 2</p>





## A5 – Special specifications for coatings on aluminium accessories for architectural applications under the QUALICOAT quality label

### 1. Introduction

Cast accessories may be made of different alloys whose chemical composition is specified in the **EN 1706** standard.

The nature of the alloy and the production method determine the final quality of the coated accessory. Some alloys – especially those based on silicone and copper – are the cause of unsatisfactory resistance to corrosion.

The chemical pretreatment cycle shall be tailored to the alloy and the quality of the castings. For outdoor architectural applications, it is necessary to use special alloys which have good resistance to corrosion as indicated in EN 1706.

It is the responsibility of the customer to define the alloy.

### 2. Work Specifications

All the requirements set out in Chapter 3 of the Specifications are applicable to the treatment of accessories, **with the exception of the etching degree** which is not specified for castings (see Specifications, [§ 3.2.1](#)).

### 3. Testing

#### 3.1 Inspection of finished products

Certain tests may be carried out on the finished products themselves but the full range of tests shall be performed on test panels processed concurrently with a production lot.

The inspector shall perform the following tests on the coated accessories:

- Appearance (Specifications [§ 2.1](#))
- Polymerisation (Specifications [§ 2.14](#))

and if the geometry of the parts permits:

- Coating thickness (Specifications [§ 2.3](#))
- Adhesion (Specifications [§ 2.4](#))

The following test shall be performed on extruded sections only:

- Acetic acid salt spray test (Specifications [§ 2.10](#))
- Machu test (Specifications [§ 2.11](#))



### 3.2 Inspection of test panels

The full range of tests shall be performed on test panels processed concurrently with a production lot.

- Gloss (Specifications § [2.2](#))
- Coating thickness (Specifications § [2.3](#))
- Adhesion (Specifications § [2.4](#))
- Bend test (Specifications § [2.7](#))
- Impact test (Specifications § [2.8](#))

Apart from the restrictions above, please refer to the QUALICOAT Specifications.



## A6 – Approval of chemical pretreatments

### 1. INTRODUCTION

This Appendix specifies the procedure for granting and renewing an approval for pretreatment processes, with the exception of chromate conversion coatings (as specified in § 3.3.1 of the QUALICOAT Specifications). It also describes the testing programme to be followed by the laboratories involved and the requirements for every test.

### 2. FORMAL APPLICATION PRIOR TO TESTING

Chemical manufacturers who plan to submit a chemical pretreatment system for testing shall send a formal request to the General Licensee or to QUALICOAT in countries without a national association using the application form available on the [QUALICOAT website](#).

If the pretreatment system is manufactured at several production plants, the applicant shall name the main production site and/or technical service centre and indicate all other production sites.

The Technical Data Sheet (TDS), a safety data sheet and detailed instructions on treatment cycles shall be submitted to an approved QUALICOAT laboratory selected in agreement with the General Licensee and/or QUALICOAT in countries without a national association.

On the application form and in the TDS, the applicant shall specify whether the product is a rinse or a no-rinse system, or whether it is suitable for dual use depending on the licensee's pretreatment line set-up. Products intended for dual use shall be tested both ways.

The following minimum technical information shall also be provided to the QUALICOAT approved laboratory in charge on a separate sheet (General Technical Information):

APPLICATION METHOD (1) (2)	
PROCESS CYCLE (2)	
FINAL RINSE (YES/NO/DUAL USE)	
ANALYTICAL METHODS FOR BATH	
FILM WEIGHT (3)	
OTHER ANALYSES	
OTHER RECOMMENDATIONS (EQUIPMENT, HANDLING, STORAGE ETC.) (4)	
COLOURLESS CONVERSION COATING?	
DRYING CONDITIONS	
<p>(1) Spraying and/or immersion. (2) The manufacturer is responsible for ensuring that the cycle used by the licensee is suitable for obtaining a coated product conforming to the QUALICOAT Specifications. What are the limits for demineralised water before conversion coating? (3) Method for in-house control and laboratory tests (limits and frequency). (4) The technical specifications shall make it clear which items are compulsory, for instance does "recommended" mean compulsory or not?</p>	



### 3. PRELIMINARY CONDITIONS (minimum equipment)

THE CHEMICAL MANUFACTURER SHALL HAVE THE FOLLOWING MINIMUM EQUIPMENT AVAILABLE AT LEAST AT ONE LOCATION (main production site and/or technical service centre):

- analytical instruments for testing the quality of the conversion coating;
- cutting tools and instruments necessary for performing the adhesion test;
- apparatus for testing dry adhesion and elasticity (cupping test);
- impact tester (ISO 6272);
- apparatus for testing resistance to cracking on bending;
- analytical balance for determining weight loss (precision 0.1 mg)
- apparatus to carry out the following corrosion tests:
  - constant climate condensation water<sup>21</sup>
  - resistance to humid atmospheres containing sulphur dioxide<sup>21</sup>
  - acetic acid salt spray resistance
  - wet adhesion test
  - filiform corrosion test<sup>21</sup>

AT ALL OTHER LOCATIONS (NOT BEING THE MAIN PRODUCTION SITE AND/OR TECHNICAL SERVICE CENTRE), THE FOLLOWING REQUIREMENTS SHALL BE MET:

- A method for testing the quality of the conversion coating shall be available.
- Tests that cannot be carried out on-site shall be performed by the laboratory at the main production site and/or technical service centre or outsourced to any QUALICOAT approved laboratory.

### 4. QUALICOAT TESTING LABORATORIES

Before an approval is granted for a new pretreatment system, the laboratory in charge shall carry out the testing programme specified in the following section. Corrosion tests shall also be performed by a second laboratory under the responsibility of the laboratory in charge.

For renewal of an approval, the full testing programme shall be carried out only by the laboratory in charge.

### 5. TESTING PROGRAMME

Approval is based on the following testing programme to ensure conformity with the requirements prescribed by QUALICOAT.

#### a) PANEL PREPARATION

For every corrosion test, six extruded samples shall be evaluated (three samples in each of the two laboratories involved). Special attention shall be paid to the preparation of samples. The final results of corrosion and exposure tests depend not only on the treatment but also on the

---

<sup>21</sup> This test may be outsourced and carried out by a QUALICOAT approved laboratory or another laboratory accredited for this specific test according to ISO 17025.



aluminium composition and the reaction between the aluminium surface and chemical products.

The chemical manufacturers shall indicate the complete pretreatment cycle to be used (degreasing etc.), and the laboratory responsible for preparing the samples shall strictly follow these instructions.

Products intended for dual use need to be tested both ways. This implies that all tests must be done in duplicate, namely once with and once without the rinse pretreatment step.

The samples may be prepared:

- either in the QUALICOAT approved laboratory under the supervision of a representative of the applicant company;
- or in the laboratory of the chemical manufacturer under the supervision of a representative of the laboratory in charge.

### **Samples**

The following alloys shall be used:

- panels for mechanical tests (thickness of 0.8 or 1 mm): **AA 5005-H24 or -H14** (AlMg 1 - semihard);
- extruded samples for corrosion tests and outdoor exposure: **AA 6060 or 6063**.

The chemical composition of the samples has an influence on the final results, especially in corrosion tests. For this reason, all laboratories shall use an alloy from the same batch to prepare the samples.

The laboratory's final report shall always indicate the chemical composition.

### **Pretreatment**

The laboratory in charge of preparing the samples shall take into account the following parameters:

- **Etching degree**  
The **total** etching degree shall be between 1.0 g/m<sup>2</sup> and 2.0 g/m<sup>2</sup> on samples for all tests.
- **Weight of the conversion coating**
  - close to the system's lower limit value specified by the chemical manufacturer, which means in the range of the lower limit value up to +33.33% of the upper limit value for corrosion test samples;
  - close to the upper limit value specified by the chemical manufacturer, which means in the range of the upper limit value down to -33.33% of the upper limit value for mechanical test samples, especially for the adhesion test.

### **Anodic pretreatment**

A pretreatment system shall be tested both ways if it is proposed to be used in combination with pre-anodised substrates, namely once with and once without the anodic pretreatment process. The necessary test samples shall be prepared according to the requirements specified by QUALICOAT in section 3.4. After this, the proposed pretreatment shall be applied to the pre-anodised panels as specified by the chemical supplier of the pretreatment system.

For identification, chemical pretreatment systems shall be listed with A-No. in the list of approved pretreatment systems and with AP-No. in case of pre-anodised material.



### Coating material to be applied

The coating system material shall have a QUALICOAT approval. Each system shall be tested with the following organic coating materials:

- class 1 powder, metallic colour (RAL 9006 or RAL 9007)
- class 2 powder, category 1, RAL 9010
- class 3 powder (when requested by the supplier).
- liquid coating (when requested by the supplier)

### **b) LABORATORY TESTS**

The following tests shall be performed

- Dry adhesion ([2.4.1](#))
- Cupping ([2.6](#))
- Bend ([2.7](#))
- Impact ([2.8](#))
- Resistance to humid atmospheres ([2.9](#))
- Acetic acid salt spray ([2.10](#))
- Wet adhesion ([2.4.2](#))
- Condensation water ([2.16](#))
- Filiform corrosion ([2.18](#))

The acceptable limits are the same as those prescribed in the QUALICOAT Specifications.

### Evaluation of laboratory test results

The final evaluation shall be as follows:

- **Result of one laboratory**

POSITIVE	0 or 1 unsatisfactory panel
NEGATIVE	2 or more unsatisfactory panels.

- **Results of two laboratories**

- If the results in both laboratories are positive, the system is satisfactory.
- If the results in both laboratories are negative, the system is unsatisfactory.
- If the results are positive in one laboratory and negative in the other, the tests shall be repeated in a third laboratory.

### **c) OUTDOOR EXPOSURE**

- **Exposure site**  
2 years in Genoa starting in September.
- **Number of panels**  
All tests shall be made in triplicate.

**Fig. 1 Scratches for outdoor exposure**

(panel dimensions: length 200 mm, width 70 – 100 mm)

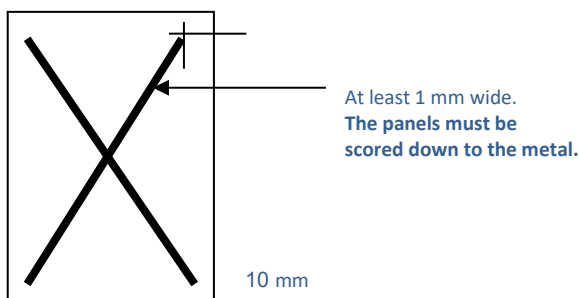

**Evaluation of exposure test results**

After 2 years of exposure, a final evaluation shall be made, applying the following criteria:

POSITIVE	0 or 1 unsatisfactory panel
NEGATIVE	2 or more unsatisfactory panels

**6. CONFORMITY ASSESSMENT**

The testing laboratory shall submit the test report and the basic documentation (TDS, safety data sheet and detailed instructions on treatment cycles) to the General Licensee or to QUALICOAT in countries where there is no General Licensee.

Under the supervision of QUALICOAT, the General Licensee shall decide whether or not to grant or renew an approval.

The results shall be communicated to the chemical manufacturers in writing.

If the results do not meet the requirements, full details and reasons shall be given. The chemical manufacturer shall be entitled to appeal within 10 days to the General Licensee or to QUALICOAT in countries where there is no General Licensee.

**7. GRANTING OF AN APPROVAL**

If all the results meet the requirements, QUALICOAT shall issue a certificate which will be automatically reissued every year for a validity period of three years.

After the exposure tests, the working group shall evaluate the results and take a decision on confirmation of the approval. The manufacturer shall be informed of the results and decisions.

**8. RENEWAL OF PRETREATMENT SYSTEM APPROVALS**

**a) Renewing pretreatment system approvals**

Approvals shall be renewed every three years, with the full testing programme including outdoor exposure (see § 5 of this Appendix) carried out by one laboratory. Once a system has been approved for six consecutive years, the renewal interval shall be extended to five years.

If an approved system identified by a single approval number is manufactured at different production sites of the same company, the full testing programme (including the exposure test) shall be carried out for the main production site and/or technical service centre. At the other production sites indicated by the chemical manufacturer, the approved pretreatment system shall be checked only with AASS and FFC tests, specifically by sending coated samples that have been treated with the



products manufactured at all other production sites to the same laboratory that is also responsible for the main production site. The respective provenance shall be clearly stated.

An approval shall be renewed if the results of the laboratory and exposure tests conform to the Specifications. The certificate shall be issued every year.

#### **b) Repetition of unsatisfactory laboratory tests**

If the laboratory test results are unsatisfactory, all corrosion tests shall be repeated in two laboratories. Renewal shall be confirmed if the results are satisfactory in both laboratories. If the results are unsatisfactory in one of the two laboratories, the approval shall be cancelled. If the result of outdoor exposure is unsatisfactory, the approval shall then be cancelled.

#### **c) AASS test '10+2' rule and FFC test '15+3' rule**

10% of failures in the AASS test and at least two C+D values classified as unsatisfactory shall lead to an unsatisfactory assessment. If only one C+D AASS test result is obtained, the pretreatment system shall be considered satisfactory.

15% of failures in the FFC test and at least three C+D values classified as unsatisfactory shall lead to an unsatisfactory assessment. If only two C+D FFC test result is obtained, the pretreatment system shall be considered satisfactory.

#### **Evaluation**

The QUALICOAT Secretariat shall determine all the chemical pretreatment systems falling under the AASS test '10+2' rule and FFC test '15+3' rule by evaluating the previous year's AASS and FFC test results from samples taken during the annual inspections at the licensees' production sites.

#### **Information**

By the end of June, at the latest, the chemical manufacturers concerned shall be informed by the General Licensee (or directly by QUALICOAT in countries without a General Licensee) that their chemical pretreatment system is being placed 'under observation' for exceeding the AASS test '10+2' rule and/or FFC test '15+3' rule.

All licensees using the chemical pretreatment system placed 'under observation' shall be informed by the General Licensee (or directly by QUALICOAT in countries without a General Licensee) by the end of July. They shall be made aware that they must continue to fully comply with the requirements of the QUALICOAT Specifications.

#### **Observation period**

The one-year observation period of the chemical pretreatment system shall start with the written notification of the chemical manufacturer by the end of June. If the chemical pretreatment system does not fall under the AASS test '10+2 rule' and/or FFC test '15+3' rule again in the subsequent calendar year, the status shall be reset, and the chemical manufacturer shall be informed by the General Licensee (or directly by QUALICOAT in countries without a General Licensee).

#### **Withdrawal**

If a system fails over two consecutive calendar years, it shall be cancelled by 30 June of the second year and the chemical manufacturer shall be notified by the General Licensee (or directly by QUALICOAT in countries without a General Licensee) that the chemical pretreatment system will be cancelled within 30 days from the notification date.





#### d) Deadline for the licensee to use the product

All licensees using the chemical pretreatment system cancelled due to the AASS test '10+2' rule and/or FFC test '15+3' rule, may continue to use it until end of the year of cancellation. They shall be made aware that they must continue to fully comply with the requirements of the QUALICOAT Specifications.

### 9. RESPONSIBILITY AND COOPERATION WITH THE LICENSEE

Manufacturers and licensees shall cooperate closely (see Chapter 3, § [3.3.2](#)).

For all systems, there shall be technical data sheets, also giving information about other products with which a system may or may not be used. The chemical manufacturer shall be responsible for all cycles used by coating applicator.

To take into account the particular conditions in each plant, a manual adapted to the coating line to be followed by the persons in charge shall be provided to the licensee and shall specify whether the product is to be used as a rinse or no-rinse system in the respective coating line. The manual adapted to the coating line shall also specify the rinsing requirements according to Chapter 3, § 3.3.2.

The methods for assessing the conversion coating may differ from one system to the next since there is not a pertinent standard. . The manufacturer indicates how the licensee has to monitor the quality of the chrome VI-free conversion coating during in-house control. A device to check the coating weight analytically and reporting a specific quantitative figure within the given range shall be prescribed. The method shall prescribe that the device shall indicate a maximum of +/- 20% deviation accuracy. QUALICOAT recommends the coating weight to be measured in every working shift, or according to the chemical manufacturer's advice, which shall be at least once per day (see table in section [6.5](#)).

Due to its uncertainty, QUALICOAT does not allow the gravimetric method to measure the weight of the conversion layer below 100 mg/m<sup>2</sup> using an analytical balance with precision 0.1 mg. The X-ray analysis and spectrophotometry are accepted methods for measuring conversion layer weight below 100 mg/m<sup>2</sup>.

The following tests shall be carried out on the production sample received every two months from the

- acetic acid salt spray resistance test
- coating weight measurement

Receipt of the samples shall be confirmed to the licensee immediately. Detailed results and any corrective actions shall be entered and retained along with the related shipping details in records readily accessible to the inspector and communicated to the licensee within a period of maximum four months.

If the chemical manufacturer fails to cooperate with the licensee within the specified deadlines, the following sanction procedure shall be followed:

A written notification (warning letter) shall be sent to the chemical manufacturer by the General Licensee or QUALICOAT in countries without a General Licensee, giving it four weeks to respond:

- 1) The chemical manufacturer shall immediately acknowledge receipt of the notification.
- 2) The chemical manufacturer shall respond with a justification letter within four weeks.



- 3) The justification shall be assessed by the General Licensee or QUALICOAT (possibly involving the Board of Governors if the decision is not obvious), which could lead to a withdrawal of the approval.
- 4) If no justification letter is submitted within four weeks, the approval shall be withdrawn. The chemical manufacturer shall need to wait at least three months before sending a new application for approval.

## 10. COMPULSORY DECLARATION OF CHANGES IN FORMULATION OF PRETREATMENTS

In principle, if the chemical composition of the conversion coating remains the same, it shall not be necessary to apply for a new approval. In practice, this means accepting all the variations specified on the technical data sheet to adjust the system to a specific application line in order to achieve the specified coating weight. The chemical product may be supplied as a two-component or single-component system. The chemical manufacturers shall guarantee that the chemical composition of the working solution is essentially the same as that approved by QUALICOAT.

Any change in formula that can result in significant changes in the composition of the conversion coating represents a new product and requires a new QUALICOAT approval.

To give a few examples of such changes, we would like to mention some clear-cut cases:

- Any change in the metal content of the coating through substitution, addition, removal, etc. of the approved metal system when the products are based on transition metals replacing chrome.
- Any change in the polymer composition and, by extension, in the organic components through substitution, addition, removal etc. when they are present in the approved formula.
- Any change in the typical appearance of the conversion coating, for example from colourless to colour.



## A6b – Preliminary sampling and testing (PST) of pretreatment-systems with modified processes or new technologies

### 1. INTRODUCTION

The pretreatment systems regulated in QUALICOAT Specifications today are, chromate conversion coatings (§ 3.3.1) and other chemical pretreatments (§ 3.3.2) in combination with different types of etching (§ 3.2.1) or anodic pretreatment (§ 3.4).

To consider the implementation of modified pretreatment processes or new technologies, [Appendix A6b](#) prescribes the procedure for preliminary sampling and testing (PST) of these new processes, prior the commencement of the approval (A-No.) testing. For pretreatment systems that fully comply to QUALICOAT Specifications and [Appendix A6](#), it is not necessary to apply for a PST request.

### 2. PRELIMINARY SAMPLING AND TESTING (PST) PROGRAMME

The QUALICOAT Executive Committee must confirm or modify the following pre-defined minimum requirements for each PST request, before proceeding with Phase 3.

The Executive Committee can intervene at any time of this procedure and name the reasons. To accelerate the PST process, the Executive Committee can give mandates.

#### PROCEDURE STEPS (PHASE 1 TO 9):

PHASE 1	Responsible	Information to
<p>Formulation of the PST request:</p> <p>Description of the complete pretreatment process in detail including all relevant process steps, parameters, values and limits as well as TDS and safety data sheet of all chemicals involved.</p> <p>Proposal for the tests (test type and requirements). Minimum test requirements according to <a href="#">Appendix A6</a> laboratory test (outdoor exposure test will be stipulated by QUALICOAT on Phase 6).</p>	Supplier	General Licensee or to QUALICOAT in countries where there is no General Licensee
PHASE 2	Responsible	Information to
<p>Review of description. Confirm or modify the following PST procedure steps.</p> <p>Naming two QUALICOAT approved laboratories and additional laboratory required in case of inconsistent test results (see Phase 5) in agreement with the GL and/or QUALICOAT in countries where there is no General Licensee. Please note that all the testing institute involved shall not be part of the same corporate group.</p> <p>Naming tests for Phase 3 and 4.</p> <p>Release for Phase 3 and 4.</p>	Executive Committee, after consultation with Convenors of Technical Committee and Pretreatment WG	Supplier



PHASE 3	Responsible	Information to
<p><b>Institute sampling:</b></p> <p>Sampling in one of the two laboratories or in supplier's factory under the supervision of the laboratory (institute sampling).</p> <p>Sampling shall include a third set of samples as required for a third laboratory in case of inconsistent test results (see Phase 6).</p> <p>Sampling may include a set of samples as required for outdoor exposure in a subsequent approval process according QUALICOAT Specifications.</p> <p><i>*Note: It is permissible to perform Phase 3 and 4 at the same time.</i></p>	Laboratories	Supplier
PHASE 4	Responsible	Information to
<p><b>Field sampling:</b></p> <p>Sampling in QUALICOAT approved coating line (field sampling) under the supervision of a QUALICOAT inspector on basis of process description and the required tests. Minimum 1000 m<sup>2</sup> of finished products (extrusions or sheets) to be coated with the samples to be taken at the beginning, in the middle and the end of the lot.</p> <p>Sampling shall include a third set of samples as required for a third laboratory in case of inconsistent test results (see Phase 6).</p> <p><i>*Note: It is permissible to perform Phase 3 and 4 at the same time.</i></p>	Supplier and Laboratories	General Licensee or to QUALICOAT in countries where there is no General Licensee
PHASE 5	Responsible	Information to
<p>Testing in the two named laboratories. Samples of institute sampling (Phase 3) and field sampling (Phase 4) should preferably be tested simultaneously in the same test apparatus (<a href="#">§ 2.9</a>, <a href="#">§ 2.10</a>, <a href="#">§ 2.4.2</a>, <a href="#">§ 2.16</a> and <a href="#">§ 2.18</a>). All tests shall be performed in triplicate. If the results of more than one panel are unsatisfactory, the respective test result shall be rated as negative.</p>	Laboratories	General Licensee or to QUALICOAT in countries where there is no General Licensee
PHASE 6	Responsible	Information to
<p>Review test results of institute sampling (Phase 3) and field sampling (Phase 4).</p> <p>If the results in both laboratories are positive, the system is satisfactory.</p> <p>If the results in both laboratories are negative, the system is unsatisfactory.</p> <p>If the results are positive in one laboratory and negative in the other, the tests shall be repeated in a third laboratory.</p>	Convenor of Pretreatment WG and QUALICOAT	Executive Committee and Technical Committee



<p>Proposal of modifications of QUALICOAT specifications, if necessary.</p> <p>Proposal to Executive Committee and Technical Committee to release for trial process and stipulating outdoor exposure tests required.</p>		
<b>PHASE 7</b>	<b>Responsible</b>	<b>Information to</b>
<p>With satisfactory test results from Phase 3 and 4, and with authorisation from the Executive and Technical Committee, the supplier can administer / operate the system in the plant used for field sampling with a six months testing programme (trial process).</p> <p>Two inspections shall be conducted which include one unannounced inspection.</p>	Supplier and Laboratories	General Licensee or to QUALICOAT in countries where there is no General Licensee
<b>PHASE 8</b>	<b>Responsible</b>	<b>Information to</b>
<p>Decision about release for approval process.</p> <p>Defining modifications of QUALICOAT specifications, if necessary.</p>	Technical Committee and Executive Committee	General Licensee or to QUALICOAT in countries where there is no General Licensee
<b>PHASE 9</b>	<b>Responsible</b>	<b>Information to</b>
<p>Informing the supplier about the decision of Executive Committee for possible approval (A-No.) process according QUALICOAT Specifications and <a href="#">Appendix A6</a>.</p> <p>Approval (A-No.) process:</p> <p>If the supplier applies for approval (A-No.) according QUALICOAT Specifications and <a href="#">Appendix A6</a>, the test results gathered in the PST process, shall be regarded as valid for the approval process as well.</p> <p>QUALICOAT shall issue an provisional approval certificate (AN-No.) which will be automatically reissued every year for a validity period equivalent to the duration of outdoor exposure testing.</p> <p>After the exposure tests, the convenors of the Technical Committee and Pretreatment WG shall evaluate the results and take a decision on transferring the provisional approval (AN-No.) to an approval (A-No.).</p>	<p>General Licensee or to QUALICOAT in countries where there is no General Licensee</p> <p>Convenors of the Technical Committee and Pretreatment WG</p>	Supplier



## A7 – Specifications for batch treatment

### 1. Introduction

For batch treatment, the products to be treated are arranged in organised loads in baskets used for immersion.

### 2. Specifications

The material used for separators and hooping shall be compatible with the chemistry used as recommended by the chemical manufacturer.

The number of separators shall be chosen to minimise contacts. The products shall be arranged with sufficient space between them to allow the liquid to pass freely through the load.

The maximum contact width between the sections shall be 2 mm.

The distance between the sections shall be at least 1 cm.

It is important to avoid any surface scratching.

### 3. Testing method to evaluate contact mark areas

Use a piece of a pretreated aluminium extrusion that has been marked by a separator. The area on the bar with the marks shall be identified.

The wet adhesion test shall be carried out according to § [2.4.2](#) on the coated samples.

Allow the test piece to cool after the test and examine it for any blistering on the identified area.

#### **Requirements:**

No sign of detachment or blistering. Cross-cut value 0. Colour change is acceptable.



### A8 – List of colour tolerances before granting or renewing an approval (for QUALICOAT laboratories) <sup>22</sup>

RAL	Tolerance	RAL	Tolerance	RAL	Tolerance	RAL	Tolerance	RAL	Tolerance	RAL	Tolerance
1000	2.0	3000	2.8	5000	2.0	6000	2.0	7000	2.0	8000	2.0
1001	2.0	3001	2.8	5001	2.0	6001	2.8	7001	2.0	8001	2.0
1002	2.0	3002	2.8	5002	2.0	6002	2.8	7002	1.4	8002	2.0
1003	3.6	3003	2.8	5003	2.0	6003	2.0	7003	1.4	8003	2.0
1004	3.6	3004	2.0	5004	2.0	6004	2.0	7004	1.0	8004	2.0
1005	3.6	3005	2.0	5005	2.0	6005	2.0	7005	1.4	8007	2.0
1006	3.6	3007	1.4	5007	2.0	6006	1.4	7006	1.4	8008	2.0
1007	3.6	3009	2.0	5008	2.0	6007	1.4	7008	2.0	8011	2.0
1011	2.0	3011	2.8	5009	2.0	6008	1.4	7009	1.4	8012	2.0
1012	2.8	3012	2.0	5010	2.0	6009	1.4	7010	1.4	8014	1.4
1013	1.0	3013	2.8	5011	2.0	6010	2.8	7011	1.4	8015	2.0
1014	2.0	3014	2.0	5012	2.0	6011	2.0	7012	1.4	8016	1.4
1015	1.0	3015	1.0	5013	2.0	6012	1.4	7013	1.4	8017	1.4
1016	2.8	3016	2.8	5014	2.0	6013	2.0	7015	1.4	8019	1.4
1017	2.8	3017	2.8	5015	2.0	6014	1.4	7016	2.0	8022	1.4
1018	2.8	3018	2.8	5017	2.0	6015	1.4	7021	1.4	8023	2.8
1019	1.0	3020	2.8	5018	2.0	6016	2.0	7022	1.4	8024	2.8
1020	2.0	3022	2.8	5019	2.0	6017	2.8	7023	1.4	8025	1.4
1021	3.6	3027	2.8	5020	2.0	6018	2.8	7024	1.4	8028	1.4
1023	3.6	3028	2.8	5021	2.0	6019	1.2	7026	2.0	9001	1.0
1024	2.0	3031	2.8	5022	2.0	6020	1.4	7030	1.0	9002	1.0
1027	2.8	4001	1.4	5023	2.0	6021	2.0	7031	2.0	9003	1.0
1028	3.6	4002	2.0	5024	2.0	6022	1.4	7032	1.0	9004	1.4
1032	3.6	4003	1.4			6024	2.8	7033	1.4	9005	1.4
1033	3.6	4004	2.0			6025	2.8	7034	1.4	9010	1.0
1034	2.8	4005	2.0			6026	2.0	7035	1.0	9011	1.4
1037	3.6	4006	1.4			6027	2.0	7036	1.0	9012	1.0
2000	3.6	4007	1.4			6028	2.0	7037	1.4	9016	1.0
2001	2.8	4008	1.4			6029	2.0	7038	1.0	9017	1.4
2002	2.8	4009	1.2			6032	2.8	7039	1.4	9018	1.0
2003	2.8	4010	2.0			6033	2.0	7040	1.0		
2004	3.6					6034	2.0	7042	1.0		
2008	3.6					6037	2.8	7043	1.4		
2009	3.6							7044	1.0		
2010	2.8							7045	1.0		
2011	3.6							7046	1.4		
2012	2.8							7047	1.0		

<sup>22</sup> The powder manufacturers shall indicate which RAL card they use on the label, so that the laboratory knows which reference to work with. QUALICOAT recommends using the RAL GL Card for categories 2 and 3 solid powder coatings and RAL HR for category 1 and for textured coatings.

The tolerance indicated in the table may be extended with a corrective factor of 1.3 for matt and textured finishes in combination with a final visual assessment.

## A9 – List of relevant standards<sup>23</sup>

Nº	YEAR	TITLE	SPECIFICATIONS
ISO 2813	2014	Paints and varnishes -- Determination of gloss value at 20° degrees, 60° and 85°	Gloss <a href="#">2.2</a> , <a href="#">2.12</a> , <a href="#">2.13</a> , <a href="#">6.3.1</a>
ISO 2360	2017	Non-conductive coatings on non-magnetic electrically conductive basis materials - Measurement of coating thickness - Amplitude-sensitive eddy current method	Coating thickness <a href="#">2.3</a> , <a href="#">6.3.2</a>
ISO 2409	2020	Paints and varnishes -- Cross-cut test	Adhesion <a href="#">2.4</a> , <a href="#">6.3.4</a>
ISO 2815	2003	Paints and varnishes -- Buchholz indentation test	Buchholz Indentation <a href="#">2.5</a>
ISO 1520	2006	Paints and varnishes -- Cupping test	Cupping test <a href="#">2.6</a>
ISO 1519	2011	Paints and varnishes -- Bend test (cylindrical mandrel)	Bend test <a href="#">2.7</a> , <a href="#">6.3.6</a>
ISO 6272-1	2011	Paints and varnishes -- Rapid-deformation (impact resistance) tests -- Part 1: Falling-weight test, large-area indenter	Impact test <a href="#">2.8</a> , <a href="#">6.3.7</a>
ISO 6272- 2	2011	Paints and varnishes -- Rapid-deformation (impact resistance) tests -- Part 2: Falling-weight test, small-area indenter	Impact test <a href="#">2.8</a> , <a href="#">6.3.7</a>
ASTM D2794	2010	Standard Test Method for Resistance of Organic Coatings to the Effects of Rapid Deformation (Impact)	Impact test <a href="#">2.8</a> , <a href="#">6.3.7</a>
ISO 22479	2019	Paints and varnishes -- Determination of resistance to humid atmospheres containing sulphur dioxide	Resistance to humid atmospheres containing sulphur dioxide <a href="#">2.9</a>
ISO 4628-2	2016	Paints and varnishes -- Evaluation of degradation of coatings -- Designation of quantity and size of defects, and of intensity of uniform changes in appearance -- Part 2: Assessment of degree of blistering	Blistering <a href="#">2.9</a> - <a href="#">2.10</a>
ISO 9227	2022	Corrosion tests in artificial atmospheres -- Salt spray tests	Acetic acid salt spray resistance <a href="#">2.10</a>

<sup>23</sup> This list refers to ISO standards and their relevant year of issue. It is continuously updated on the Internet ([www.qualicoat.net](http://www.qualicoat.net)).





Nº	YEAR	TITLE	SPECIFICATIONS
ISO 16474- 2	2013	Paints and varnishes – Method of exposure to laboratory light sources –Part 2 – Xenon-arc lamps	Accelerated weathering test <a href="#">2.12</a>
ISO 11664-4	2019	Colorimetry -- Part 4: CIE 1976 L*a*b* Colour space	Colour variation <a href="#">2.12– 2.13</a>
ISO 2810	2020	Paints and varnishes -- Natural weathering of coatings -- Exposure and assessment	Natural weathering test <a href="#">2.13</a>
EN 12206-1	2021	Paints and varnishes – Coating of aluminium and aluminium alloys for architectural purposes – Part 1: Coatings prepared from coating powder	Resistance to mortar <a href="#">2.15</a>
ISO 6270-2	2017	Paints and varnishes – Determination of resistance to humidity – Part 2: Procedure for exposing test specimens in condensation – water atmospheres	Constant climate condensation water test <a href="#">2.16</a>
ISO 4623–2	2003	Paints and varnishes – Determination of resistance to filiform corrosion – Part 2 Aluminium substrates	Filiform corrosion test <a href="#">2.18</a>
ISO 4628-10	2016	Paints and varnishes - Evaluation of degradation of coatings - Designation of quantity and size of defects, and of intensity of uniform changes in appearance – Part 10 Assessment of degree of filiform corrosion	Filiform corrosion test <a href="#">2.18</a>
CEN/TS 16611	2016	Furniture - Assessment of the surface resistance to microscratching	Scratch and mar resistance test (Martindale) <a href="#">2.20</a>
EN 12487	2007	Chemical conversion coatings – Rinsed and non-rinsed chromate conversion coatings on aluminium and aluminium alloys	Chromate conversion <a href="#">3.3.1</a>
ISO 3892	2000	Conversion coatings on metallic materials -- Determination of coating mass per unit area -- Gravimetric methods	Chromate conversion <a href="#">6.2.2</a>
EN 1706	2020 + A1: 2021	Aluminium and aluminium alloys - Castings - Chemical composition and mechanical properties	Cast accessories <a href="#">Appendix A5</a>



## A10 – Summary of requirements for the approval of organic coating materials (all classes)

TESTS	STANDARDS	QUALICOAT SPECIFICATIONS			
		CLASS 1	CLASS 1.5	CLASS 2	CLASS 3
COLOUR 2.1	ISO 11664-4	The colour deviation from the certified RAL card shall not be greater than the limit prescribed in <a href="#">Appendix A8</a> .	Same as class 1	Same as class 1	Same as class 1
GLOSS 2.2	ISO 2813	Permissible variation from the nominal value specified by the coating supplier:  Gloss cat. 1: 0 – 30 +/- 5 units Gloss cat. 2: 31 - 70 +/-7 units Gloss cat. 3: 71 – 100 +/- 10 units	Same as class 1	Same as class 1	Same as class 1
COATING THICKNESS 2.3	ISO 2360	Minimum thickness = 60 µm None of the values measured shall be less than 80% of the specified minimum value	Same as class 1	Same as class 1	Minimum thickness= 50 µm None of the values measured shall be less than 80% of the specified minimum value
DRY ADHESION 2.4.1	ISO 2409	The result shall be 0.	Same as class 1	Same as class 1	Same as class 1
BUCHHOLZ INDENTATION 2.5	ISO 2815	Minimum 80 with the specified required coating thickness	Same as class 1	Same as class 1	Same as class 1
CUPPING TEST 2.6	ISO 1520	Minimum 5 mm Using normal corrected vision, the coating shall not show any sign of cracking or detachment.	Minimum 5 mm Using normal corrected vision, the coating shall not show any sign of detachment following the <a href="#">tape pull adhesion test</a> .	Same as class 1.5	Same as classes 1.5
BEND TEST 2.7	ISO 1519	Using normal corrected vision, the coating shall not show any sign of cracking or detachment.	Using normal corrected vision, the coating shall not show any sign of detachment following the <a href="#">tape pull adhesion test</a> .	Same as class 1.5	Same as classes 1.5
IMPACT TEST 2.8	ISO 6272 ASTM D 2794	Using normal corrected vision, the coating shall not show any sign of cracking or detachment.	Using normal corrected vision, the coating shall not show any sign of detachment following the <a href="#">tape pull adhesion test</a> .	Same as class 1.5	Same as classes 1.5



TESTS	STANDARDS	QUALICOAT SPECIFICATIONS			
		CLASS 1	CLASS 1.5	CLASS 2	CLASS 3
RESISTANCE TO HUMID ATMOSPHERES <a href="#">2.9</a>	ISO 22479	<p><b>After 24 cycles</b> No infiltration exceeding 1 mm on both sides of the scratch, and no change in colour or blisters in excess of 2 (S2) according to ISO 4628-2.</p>	Same as class 1	Same as class 1	Same as class 1
ACETIC ACID SALT SPRAY RESISTANCE <a href="#">2.10</a>	ISO 9227	<p><b>Testing time: 1000 hours</b></p> <p><b>RATING A</b> = 3 samples ok, 0 not ok <b>RATING B</b> = 2 samples ok, 1 not ok <b>RATING C</b> = 1 sample ok, 2 not ok <b>RATING D</b> = 0 sample ok, 3 not ok</p> <p><b>Evaluation:</b></p> <p><b>A/B</b> : test result satisfactory <b>C</b>: test result unsatisfactory (repetition of the AASS test) <b>D</b>: test result unsatisfactory (repetition of all laboratory tests)</p>	Same as class 1	Same as class 1	<p><b>Testing time: 2000 hours</b></p> <p><b>Evaluation: same as class 1</b></p>
ACCELERATED WEATHERING TEST <a href="#">2.12</a>	ISO 16474-2 (except for class 3)	<p><b>Exposure time: 1000 hours</b></p> <p><b>Gloss retention:</b> at least 50%</p> <p><b>Colour change:</b> according to the ΔE values stipulated in <a href="#">Appendix A12</a>.</p>	<p><b>Exposure time: 1000 hours</b></p> <p><b>Gloss retention:</b> at least 75%</p> <p><b>Colour change:</b> not greater than 75% of the limits prescribed in <a href="#">Appendix A12</a></p>	<p><b>Exposure time: 1000 hours</b></p> <p><b>Gloss retention:</b> at least 90%</p> <p><b>Colour change:</b> not greater than 50% of the limits prescribed in <a href="#">Appendix A12</a></p>	<p><b>Exposure time: 3 years in Florida</b></p> <p><b>Gloss retention:</b> at least 80%</p> <p><b>Colour change:</b> not greater than 50% of the limits prescribed in <a href="#">Appendix A12</a></p>
POLYMERISATION TEST <a href="#">2.14</a> OPTIONAL	----	<p><b>Ratings:</b></p> <p>1: very dull and quite soft coating 2: very dull coating which can be scratched with a finger-nail. 3: slight loss of gloss i.e. less than 5 units 4: no perceptible change. Coating cannot be scratched with a finger-nail.</p> <p><b>Evaluation:</b></p> <p><b>1/2:</b> test result unsatisfactory <b>3/4:</b> test result satisfactory</p>	Same as class 1	Same as class 1	Same as class 1
RESISTANCE TO MORTAR <a href="#">2.15</a>	EN 12206-1 par. 5.9	There shall not be any change in appearance/colour after the mortar test.	Same as class 1	Same as class 1	Same as class 1



TESTS	STANDARDS	QUALICOAT SPECIFICATIONS			
		CLASS 1	CLASS 1.5	CLASS 2	CLASS 3
WET ADHESION <a href="#">2.4.2</a>	ISO 2409	Using normal corrected vision, the coating shall not show any sign of blistering or detachment.	Same as class 1	Same as class 1	Same as class 1
CONSTANT CLIMATE CONDENSATION WATER TEST <a href="#">2.16</a>	ISO 6270	<p><b>Testing time: 1000 hours</b></p> <p>No blistering in excess of 2 (S2) according to ISO 4628-2; the maximum infiltration at the cross is 1 mm.</p>	Same as class 1	Same as class 1	<p><b>Testing time: 2000 hours</b></p> <p>No blistering in excess of 2 (S2) according to ISO 4628-2; the maximum infiltration at the cross is 1 mm.</p>
WATER SPOT TEST <a href="#">2.19</a>	---	<p><b>Colour change</b></p> <p>The ΔL value shall be less than 4</p>	Same as class 1	Same as class 1	Same as class 1
SCRATCH AND MAR RESISTANCE TEST (Martindale) <a href="#">2.20</a>	CEN/TS 16611	<p><b>Gloss retention</b></p> <ul style="list-style-type: none"> <li>• 40% for coatings with smooth appearance</li> <li>• 60% for organic coatings with structured appearance</li> </ul>	Same as class 1	<p><b>Gloss retention</b></p> <p>30% for coatings with smooth appearance</p> <p>60% for organic coatings with structured appearance</p>	Same as class 2
NATURAL WEATHERING TEST (FLORIDA) <a href="#">(2.13)</a>	ISO 2810	<p><b>5° south</b></p> <p>4 panels per colour shade</p> <p><b>Exposure time:</b></p> <p>1 year</p> <p><b>Gloss retention</b></p> <p>at least 50%</p> <p><b>Colour change:</b></p> <p>The ΔE values shall not exceed the maximum values stipulated in <a href="#">Appendix A12</a></p>	<p><b>5° south</b></p> <p>7 panels per colour shade</p> <p><b>Exposure time:</b></p> <p>2 years with an annual evaluation</p> <p><b>Gloss retention</b></p> <p>After 1 year : at least 65%</p> <p>After 2 years : at least 50%</p> <p><b>Colour change:</b></p> <p>After 2 years: within the limits prescribed in <a href="#">Appendix A12</a></p>	<p><b>5° south</b></p> <p>10 panels per colour shade</p> <p><b>Exposure time:</b></p> <p>3 years with an annual evaluation</p> <p><b>Gloss retention</b></p> <p>After 1 year : at least 75%</p> <p>After 2 years : at least 60%</p> <p>After 3 years : at least 50%</p> <p><b>Colour change:</b></p> <p>After 3 years: within the limits prescribed in <a href="#">Appendix A12</a>.</p>	<p><b>45° south</b></p> <p>13 panels per colour shade</p> <p><b>Exposure time:</b></p> <p>10 years with an evaluation after 3, 5 and 7 years</p> <p><b>Gloss retention</b></p> <p>After 3 years: at least 80%</p> <p>After 5 years: at least 70%</p> <p>After 7 years :at least 60%</p> <p>After 10 years: at least 50%</p> <p><b>Colour change:</b></p> <p>After 3 years : max. 50% of the limits prescribed in <a href="#">Appendix A12</a></p> <p>After 10 years: within the limits prescribed in</p>



## A11 – RAL families and critical colours

### 1. Introduction

QUALICOAT has introduced the concept of RAL families for class 2 and class 3 organic coatings in the specifications for colour change after the natural weathering test (see § 4.2.1) because if a manufacturer’s coating material shows a colour change failure in one RAL colour after Florida exposure, this indicates a technological deficiency affecting similar colours.

### 2. Critical colours and classification of RAL families for class 2

30 groups of homogeneous colours (solid colours of a similar hue and shade) have been defined as RAL families for renewals of class 2 approvals. QUALICOAT has excluded 9 critical RAL colours which, as powder coating technology stands today, do not have sufficient resistance to colour change after 3 years of outdoor exposure.

SUMMARY	
Number of solid RAL colours (excluding metallic and pearl RAL colours)	191
Solid RAL colours (non-critical)	182
Critical solid RAL colours	9
Number of RAL families	30

9 CRITICAL RAL COLOURS (colours excluded from the RAL families)			
RAL 1003	RAL 2004	RAL 3015	RAL 4001
RAL 1028	RAL 2011	RAL 3017	
RAL 1033		RAL 3018	

182 SOLID RAL COLOURS (non-critical)	
30 RAL FAMILIES	

RAL 1XXX	FAMILY 1/A	FAMILY 1/B	FAMILY 1/C	FAMILY 1/D
DESCRIPTION	IVORY AND BEIGE	GREENISH YELLOW	REDDISH YELLOW	OCHRE / DARK YELLOW
RAL	1000 - 1001 - 1002 - 1013 - 1014 - 1015	1012 - 1016 – 1018 - 1021 - 1023	1004 - 1005 - 1006 - 1007 - 1017 - 1032 - 1034 - 1037	1011 - 1019 - 1020 - 1024 - 1027
Total 24 colours	6	5	8	5

RAL 2XXX	FAMILY 2/A	FAMILY 2/B
DESCRIPTION	YELLOWISH ORANGE	REDDISH ORANGE
RAL	2000 - 2003 - 2008 - 2009 - 2010	2001 - 2002 - 2012
Total 8 colours	5	3



RAL 3XXX	FAMILY 3/A	FAMILY 3/B	FAMILY 3/C
DESCRIPTION	LIGHT RED AND PINK	RED	DARK RED
RAL	3012 - 3014 - 3022	3000 - 3001 - 3002 - 3003 - 3013 - 3016 - 3020 - 3027 - 3028 - 3031	3004 - 3005 - 3007 - 3009 - 3011
<b>Total 18 colours</b>	3	10	5

RAL 4XXX	FAMILY 4/A	FAMILY 4/B	FAMILY 4/C
DESCRIPTION	REDDISH VIOLET	BLUEISH VIOLET	DARK AND PASTEL VIOLET
RAL	4002 - 4003 - 4010	4004 - 4005 - 4006 - 4008	4007 - 4009
<b>Total 9 colours</b>	3	4	2

RAL 5XXX	FAMILY 5/A	FAMILY 5/B	FAMILY 5/C	FAMILY 5/D
DESCRIPTION	REDDISH BLUE	GREENISH BLUE	DARK BLUE	LIGHT BLUE
RAL	5000 - 5002 - 5003 - 5005 - 5010 - 5013 - 5017 - 5022	5001 - 5007 - 5009 - 5018 - 5019 - 5021	5004 - 5008 - 5011 - 5020	5012 - 5014 - 5015 - 5023 - 5024
<b>Total 23 colours</b>	8	6	4	5

RAL 6XXX	FAMILY 6/A	FAMILY 6/B	FAMILY 6/C	FAMILY 6/D	FAMILY 6/E
DESCRIPTION	BLUISH GREEN	YELLOWISH GREEN	INORGANIC GREEN	DARK GREEN	LIGHT GREEN
RAL	6000 - 6004 - 6005 - 6009 - 6016 - 6026	6001 - 6002 - 6006 - 6010 - 6017 - 6018 - 6024 - 6029 - 6032 - 6033 - 6037	6003 - 6011 - 6013 - 6014 - 6025 - 6028	6007 - 6008 - 6012 - 6015 - 6020 - 6022	6019 - 6021 - 6027 - 6034
<b>Total 33 colours</b>	6	11	6	6	4

RAL 7XXX	FAMILY 7/A	FAMILY 7/B	FAMILY 7/C
DESCRIPTION	LIGHT GREY WITH L > 70	MEDIUM GREY WITH L < 70 AND > 50	DARK GREY WITH L < 50
RAL	7032 - 7035 - 7038 - 7044 - 7047	7000 - 7001 - 7002 - 7003 - 7004 - 7005 - 7023 - 7030 - 7033 - 7034 - 7036 - 7037 - 7040 - 7042 - 7045 - 7046	7006 - 7008 - 7009 - 7010 - 7011 - 7012 - 7013 - 7015 - 7016 - 7021 - 7022 - 7024 - 7026 - 7031 - 7039 - 7043
<b>Total 37 colours</b>	5	16	16



<b>RAL 8XXX</b>	<b>FAMILY 8/A</b>	<b>FAMILY 8/B</b>	<b>FAMILY 8/C</b>
<b>DESCRIPTION</b>	<b>LIGHT BROWN</b>	<b>MEDIUM BROWN</b>	<b>DARK BROWN</b>
RAL	8000 - 8001 -8004- 8023 - 8024 -8025	8002 - 8003 - 8007 -8008 - 8012 - 8015	8011- 8014 - 8016 - 8017 - 8019 - 8022 - 8028
<b>Total 19 colours</b>	6	6	7

<b>RAL 9XXX</b>	<b>FAMILY 9/A</b>	<b>FAMILY 9/B</b>	<b>FAMILY 9/C</b>
<b>DESCRIPTION</b>	<b>WHITE</b>	<b>CREAM AND GREY WHITE</b>	<b>BLACK</b>
RAL	9003 -9010 – 9012 - 9016	9001- 9002 - 9018	9004 - 9005 - 9011- 9017
<b>Total 11 colours</b>	4	3	4



### 3. Critical colours and classification of RAL families for class 3

16 groups of homogeneous colours (solid colours of a similar hue and shade) have been defined as RAL families for the renewal of class 3 approvals.

4 RAL families match lightness category LIGHT (CIELAB L\* > 70), 6 match lightness category MEDIUM (CIELAB L\* between 40 and 70), and 6 match lightness category DARK ((CIELAB L\* < 40).

QUALICOAT has excluded **89 critical RAL colours**, which, as powder coating technology stands today, do not have sufficient resistance to colour change after 10 years of outdoor exposure.

89 CRITICAL RAL COLOURS (colours excluded from the RAL families)						
RAL 1004	RAL 1003	RAL 2000	RAL 3000	RAL 4001	RAL 5001	RAL 6001
RAL 1005	RAL 1012	RAL 2001	RAL 3001	RAL 4002	RAL 5002	RAL 6002
RAL 1006	RAL 1016	RAL 2002	RAL 3002	RAL 4003	RAL 5003	RAL 6003
RAL 1007	RAL 1018	RAL 2003	RAL 3003	RAL 4004	RAL 5005	RAL 6006
RAL 1017	RAL 1021	RAL 2004	RAL 3004	RAL 4005	RAL 5009	RAL 6007
RAL 1032	RAL 1023	RAL 2008	RAL 3013	RAL 4006	RAL 5010	RAL 6008
RAL 1034	RAL 1027	RAL 2009	RAL 3014	RAL 4007	RAL 5011	RAL 6011
RAL 1037	RAL 1028	RAL 2010	RAL 3015	RAL 4008	RAL 5012	RAL 6012
	RAL 1033	RAL 2011	RAL 3016	RAL 4009	RAL 5013	RAL 6013
		RAL 2012	RAL 3017	RAL 4010	RAL 5019	RAL 6014
			RAL 3018		RAL 5020	RAL 6015
			RAL 3020		RAL 5022	RAL 6016
			RAL 3022			RAL 6018
			RAL 3027			RAL 6019
			RAL 3028			RAL 6020
			RAL 3031			RAL 6022
						RAL 6024
						RAL 6025
						RAL 6026
						RAL 6027
						RAL 6029
						RAL 6032
						RAL 6034
						RAL 6037

SUMMARY	
Number of solid RAL colours (excluding metallic and pearl RAL colours)	190
Solid RAL colours (non-critical)	101
Critical solid RAL colours	89
Number of RAL families	16
Lightness category LIGHT (L>70)	4 RAL families - 21 RAL colours
Lightness category MEDIUM (<70 > 40)	6 RAL families - 52 RAL colours
Lightness category DARK (L<40)	6 RAL families - 28 RAL colours





**101 SOLID RAL COLOURS (non-critical)<sup>24</sup>**  
**16 RAL FAMILIES**

RAL 1XXX	FAMILY 1/LIGHT	FAMILY 1/MEDIUM
DESCRIPTION	IVORY AND BEIGE	OCHRE / YELLOW MEDIUM
RAL	1000 - 1001 - 1002 - 1013 -1014 – <u>1015</u>	<u>1011</u> - 1019 - 1020 -1024
<b>Total 10 colours</b>	<b>6</b>	<b>4</b>

RAL 3XXX	FAMILY 3/MEDIUM	FAMILY 3/DARK
DESCRIPTION	LIGHT RED AND PINK	DARK RED
RAL	3012*	3005* - 3007* - 3009* - 3011*
<b>Total 5 colours</b>	<b>1</b>	<b>4</b>

RAL 5XXX	FAMILY 5/LIGHT	FAMILY 5/MEDIUM	FAMILY 5/DARK
DESCRIPTION	LIGHT BLUE	MEDIUM BLUE	DARK BLUE
RAL	5014* - 5015* - 5023* - 5024*	5000* - 5007* - 5017* - 5018* - 5021*	5004* -5008*
<b>Total 11 colours</b>	<b>4</b>	<b>5</b>	<b>2</b>

RAL 6XXX	FAMILY 6/MEDIUM	FAMILY 6/DARK
DESCRIPTION	MEDIUM GREEN	DARK GREEN
RAL	6000* –6010* – 6017*- 6021* - 6033*	6004* – 6005* - 6009* - 6028*
<b>Total 9 colours</b>	<b>5</b>	<b>4</b>

RAL 7XXX	FAMILY 7/LIGHT	FAMILY 7/MEDIUM	FAMILY 7/DARK
DESCRIPTION	LIGHT GREY	MEDIUM GREY	DARK GREY
RAL	7032 – <u>7035</u> - 7038 - 7044 - 7047	7000 - 7001 - 7002 - 7003 - 7004 - 7005 - 7006 - 7008 - 7009 - 7010 - 7011 - 7012 - 7015 - 7023 - 7030 - 7031 - 7033 - 7034 - 7036 - 7037 - 7039 - <u>7040</u> - 7042 – 7043 - 7045 - 7046	7013 – <u>7016</u> - 7021 - 7022 - 7024 - 7026
<b>Total 37 colours</b>	<b>5</b>	<b>26</b>	<b>6</b>

<sup>24</sup> Colours underlined = basic colours (see Section 4.1.4)

\* These colours have to be assessed every two years.



<b>RAL 8XXX</b>	<b>FAMILY 8/MEDIUM</b>	<b>FAMILY 8/DARK</b>
<b>DESCRIPTION</b>	<b>MEDIUM BROWN</b>	<b>DARK BROWN</b>
RAL	8000 - 8001 - 8002 - 8003 - 8004 - 8008 - 8012 - 8015 - 8023 - <u>8024</u> - 8025	8007 - 8011 - 8014 - 8016 - 8017 - <u>8019</u> - 8022 - 8028
<b>Total 19 colours</b>	<b>11</b>	<b>8</b>

<b>RAL 9XXX</b>	<b>FAMILY 9/LIGHT</b>	<b>FAMILY 9/DARK</b>
<b>DESCRIPTION</b>	<b>WHITE - CREAM AND GREY WHITE</b>	<b>BLACK</b>
RAL	9001 - 9002 - 9003 - <u>9010</u> - 9016 - 9018	9004 - <u>9005</u> - 9011 - 9017
<b>Total 10 colours</b>	<b>6</b>	<b>4</b>



## A12 – Lists of colour tolerances after weathering tests for granting or renewing an approval

Colour tolerances after the weathering test for Class 1 & 1.5 organic coatings <sup>25</sup>																	
RAL	Δ E	RAL	Δ E	RAL	Δ E	RAL	Δ E	RAL	Δ E	RAL	Δ E	RAL	Δ E	RAL	Δ E	RAL	Δ E
1000	3.0	2000	4.0	<u>3000</u>	5.0	4001	4.0	5000	4.0	6000	4.0	7000	3.0	8000	3.0	<u>9001</u>	2.0
<u>1001</u>	3.0	<u>2001</u>	5.0	3001	5.0	4002	4.0	5001	4.0	6001	4.0	<u>7001</u>	3.0	<u>8001</u>	3.0	<u>9002</u>	2.0
1002	3.0	2002	6.0	<u>3002</u>	5.0	<u>4003</u>	5.0	<u>5002</u>	4.0	<u>6002</u>	4.0	7002	3.0	8003	3.0	<u>9003</u>	2.0
<u>1003</u>	4.0	2003	6.0	<u>3003</u>	4.0	4004	4.0	<u>5003</u>	4.0	<u>6003</u>	4.0	7003	3.0	8004	3.0	<u>9004</u>	4.0
<u>1004</u>	4.0	<u>2004</u>	4.0	3004	4.0	<u>4005</u>	4.0	5004	4.0	6004	4.0	<u>7004</u>	3.0	<u>8007</u>	3.0	<u>9005</u>	4.0
1005	5.0	2008	6.0	<u>3005</u>	4.0	4006	4.0	<u>5005</u>	4.0	<u>6005</u>	3.0	7005	3.0	<u>8008</u>	3.0	<u>9006</u>	2.0
1006	5.0	<u>2009</u>	4.0	3007	4.0	4007	4.0	<u>5007</u>	3.0	6006	4.0	7006	3.0	<u>8011</u>	3.0	<u>9007</u>	2.0
<u>1007</u>	5.0	2010	6.0	<u>3009</u>	4.0	4008	4.0	<u>5008</u>	4.0	6007	3.0	7008	3.0	<u>8012</u>	3.0	<u>9010</u>	2.0
<u>1011</u>	3.0	2011	6.0	<u>3011</u>	4.0	4009	4.0	5009	4.0	6008	3.0	7009	3.0	<u>8014</u>	3.0	<u>9011</u>	4.0
<u>1012</u>	3.0	2012	4.0	<u>3012</u>	2.0	4010	4.0	<u>5010</u>	4.0	<u>6009</u>	4.0	7010	3.0	8015	3.0	9012	2.0
<u>1013</u>	2.0			3013	5.0			<u>5011</u>	4.0	<u>6010</u>	4.0	7011	3.0	8016	3.0	<u>9016</u>	2.0
1014	3.0			3014	4.0			5012	4.0	<u>6011</u>	4.0	<u>7012</u>	3.0	<u>8017</u>	3.0	9018	2.0
<u>1015</u>	2.0			3015	4.0			5013	4.0	<u>6012</u>	3.0	7013	3.0	<u>8019</u>	3.0	9022	2.0
1016	6.0			<u>3016</u>	5.0			<u>5014</u>	4.0	<u>6013</u>	3.0	<u>7015</u>	3.0	8022	3.0		
1017	3.0			3017	8.0			<u>5015</u>	3.0	<u>6014</u>	4.0	<u>7016</u>	3.0	<u>8023</u>	3.0		
1018	6.0			<u>3018</u>	6.0			<u>5017</u>	4.0	6015	3.0	<u>7021</u>	3.0	8024	3.0		
<u>1019</u>	3.0			<u>3020</u>	4.0			5018	4.0	<u>6016</u>	4.0	<u>7022</u>	3.0	8025	3.0		
<u>1020</u>	3.0			<u>3022</u>	4.0			5019	4.0	<u>6017</u>	4.0	7023	3.0	<u>8028</u>	3.0		
1021	6.0			3027	5.0			5020	4.0	<u>6018</u>	4.0	<u>7024</u>	3.0				
1023	6.0			3031	4.0			5021	4.0	6019	2.0	7026	3.0				
1024	3.0							5022	4.0	<u>6020</u>	3.0	7030	3.0				
1027	3.0							<u>5023</u>	4.0	<u>6021</u>	2.0	7031	3.0				
<u>1028</u>	8.0							5024	4.0	6022	3.0	<u>7032</u>	2.0				
1032	5.0									<u>6024</u>	3.0	7033	3.0				
1033	8.0									6025	4.0	7034	3.0				
1034	4.0									<u>6026</u>	4.0	<u>7035</u>	2.0				
1037	5.0									6027	2.0	7036	3.0				
										6028	4.0	<u>7037</u>	3.0				
										<u>6029</u>	4.0	<u>7038</u>	2.0				
										<u>6032</u>	3.0	<u>7039</u>	3.0				
										<u>6033</u>	3.0	<u>7040</u>	3.0				
										<u>6034</u>	2.0	<u>7042</u>	3.0				
												<u>7043</u>	3.0				
												<u>7044</u>	2.0				
												7045	3.0				
												7046	3.0				
												<u>7047</u>	2.0				

<sup>25</sup> Underlined colours are colours that have already been tested.



Colour tolerances after the weathering test for Class 2 organic coatings <sup>26</sup>																	
RAL	Δ E	RAL	Δ E	RAL	Δ E	RAL	Δ E	RAL	Δ E	RAL	Δ E	RAL	Δ E	RAL	Δ E	RAL	Δ E
1000	3.0	2000	6.0	<u>3000</u>	6.0	4002	4.0	5000	4.0	6000	5.0	7000	4.0	8000	4.0	<u>9001</u>	2.0
1001	3.0	<u>2001</u>	5.0	3001	6.0	<u>4003</u>	5.0	<u>5001</u>	4.0	6001	5.0	<u>7001</u>	3.0	<u>8001</u>	3.0	<u>9002</u>	2.0
<u>1002</u>	3.0	2002	8.0	<u>3002</u>	6.0	4004	5.0	<u>5002</u>	4.0	<u>6002</u>	4.0	7002	4.0	8003	3.0	<u>9003</u>	2.0
<u>1004</u>	4.0	2003	6.0	<u>3003</u>	4.0	<u>4005</u>	4.0	<u>5003</u>	4.0	<u>6003</u>	5.0	7003	4.0	8004	4.0	<u>9004</u>	5.0
1005	6.0	2008	6.0	3004	4.0	4006	5.0	5004	5.0	6004	5.0	<u>7004</u>	4.0	<u>8007</u>	4.0	<u>9005</u>	5.0
1006	6.0	<u>2009</u>	4.0	<u>3005</u>	4.0	4007	5.0	<u>5005</u>	4.0	<u>6005</u>	3.0	7005	4.0	8008	4.0	<u>9006</u>	2.0
<u>1007</u>	6.0	2010	6.0	<u>3007</u>	4.0	4008	4.0	<u>5007</u>	3.0	6006	4.0	7006	4.0	<u>8011</u>	4.0	<u>9007</u>	2.0
<u>1011</u>	3.0	2012	4.0	<u>3009</u>	4.0	4009	4.0	<u>5008</u>	5.0	6007	4.0	7008	4.0	8012	4.0	<u>9010</u>	2.0
1012	3.0			<u>3011</u>	5.0	4010	5.0	5009	4.0	6008	5.0	7009	4.0	<u>8014</u>	3.0	<u>9011</u>	5.0
<u>1013</u>	2.0			<u>3012</u>	2.0			<u>5010</u>	4.0	<u>6009</u>	4.0	7010	4.0	8015	4.0	<u>9012</u>	2.0
1014	3.0			3013	6.0			<u>5011</u>	5.0	<u>6010</u>	5.0	7011	4.0	8016	4.0	<u>9016</u>	2.0
<u>1015</u>	2.0			3014	4.0			5012	4.0	<u>6011</u>	4.0	<u>7012</u>	4.0	<u>8017</u>	4.0	9018	2.0
1016	6.0			<u>3016</u>	5.0			5013	5.0	<u>6012</u>	4.0	7013	4.0	<u>8019</u>	3.0	9022	2.0
1017	3.0			3020	4.0			<u>5014</u>	4.0	<u>6013</u>	3.0	7015	4.0	8022	5.0		
1018	6.0			<u>3022</u>	4.0			<u>5015</u>	3.0	<u>6014</u>	4.0	<u>7016</u>	3.0	<u>8023</u>	4.0		
<u>1019</u>	2.5			3027	6.0			<u>5017</u>	5.0	6015	4.0	<u>7021</u>	4.0	8024	4.0		
<u>1020</u>	6.0			3031	4.0			5018	5.0	<u>6016</u>	5.0	<u>7022</u>	4.0	8025	4.0		
1021	6.0							<u>5019</u>	4.0	<u>6017</u>	5.0	7023	3.0	<u>8028</u>	3.0		
1023	3.0							5020	5.0	<u>6018</u>	4.0	7024	4.0				
1024	3.0							5021	4.0	6019	2.0	7026	4.0				
1027	3.0							5022	5.0	<u>6020</u>	2.0	7030	2.0				
1032	6.0							<u>5023</u>	4.0	<u>6021</u>	4.0	7031	4.0				
1034	4.0							5024	4.0	6022	4.0	<u>7032</u>	2.0				
1037	6.0									<u>6024</u>	3.0	7033	3.0				
										6025	5.0	7034	3.0				
										<u>6026</u>	5.0	<u>7035</u>	2.0				
										6027	2.0	7036	3.0				
										6028	5.0	<u>7037</u>	2.5				
										<u>6029</u>	4.0	<u>7038</u>	2.0				
										<u>6032</u>	3.0	<u>7039</u>	4.0				
										<u>6033</u>	2.0	<u>7040</u>	3.0				
										<u>6034</u>	2.0	<u>7042</u>	3.0				
												<u>7043</u>	3.0				
												<u>7044</u>	2.0				
												7045	3.0				
												7046	4.0				
												<u>7047</u>	2.0				

<sup>26</sup> Underlined colours are colours that have already been tested.



Colour tolerances after the weathering test for Class 3 organic coatings													
RAL	Δ E	RAL	Δ E	RAL	Δ E	RAL	Δ E	RAL	Δ E	RAL	Δ E	RAL	Δ E
1000	3.0	3005	5.0	5000	5.0	6000	5.0	7000	4.0	8000	4.0	9001	3.0
1001	3.0	3007	5.0	5004	5.0	6004	5.0	7001	4.0	<u>8001</u>	4.0	9002	3.0
1002	3.0	3009	5.0	5007	5.0	6005	5.0	7002	4.0	8002	4.0	9003	3.0
1011	3.0	3011	5.0	5008	5.0	6009	5.0	7003	4.0	8003	4.0	9004	5.0
<u>1013</u>	3.0	3012	5.0	5014	5.0	6010	5.0	7004	4.0	8004	4.0	<u>9005</u>	5.0
1014	3.0			5015	5.0	6017	5.0	7005	4.0	8007	4.0	<u>9006</u>	4.0
1015	3.0			5017	5.0	<u>6021</u>	5.0	7006	4.0	8008	4.0	<u>9007</u>	4.0
1019	3.0			5018	5.0	6028	5.0	7008	4.0	8011	4.0	<u>9010</u>	3.0
1020	6.0			5021	5.0	6033	5.0	7009	4.0	8012	4.0	9011	5.0
<u>1024</u>	3.0			5023	5.0			7010	4.0	<u>8014</u>	4.0	9016	3.0
				5024	5.0			7011	4.0	8015	4.0	9017	5.0
								7012	4.0	8016	4.0	9018	3.0
								7013	4.0	8017	4.0	9022	4.0
								<u>7015</u>	4.0	8019	4.0		
								<u>7016</u>	4.0	8022	5.0		
								7021	4.0	8023	4.0		
								7022	4.0	<u>8024</u>	4.0		
								7023	4.0	8025	4.0		
								7024	4.0	8028	4.0		
								7026	4.0				
								7030	4.0				
								7031	4.0				
								<u>7032</u>	3.0				
								7033	4.0				
								7034	4.0				
								7035	3.0				
								7036	4.0				
								7037	4.0				
								7038	3.0				
								7039	4.0				
								7040	4.0				
								7042	4.0				
								7043	4.0				
								7044	3.0				
								7045	4.0				
								7046	4.0				
								<u>7047</u>	3.0				



## A14 – Specifications for Powder coated Material suitable for Postforming

### A14 – 1 Introduction

#### A14 - 1.1 Scope of this appendix

According to Chapter 1. 'General Information', the QUALICOAT Specifications do apply to postforming, provided specific requirements defined in Appendix A14 are met.

The scope of this appendix is to establish the minimum requirements that plant installations, organic coating materials, processes, and finished products shall meet for postforming applications.

#### A14 - 1.2 Suitable aluminium material

The material destined to postforming the aluminium sheets and coils shall be in accordance with EN 485-2.

The mechanical characteristics and bending quality of the aluminium substrate shall be according to those requested for the coated final product; it must be remembered that the permissible bend radii are governed by the choice of the Al alloy, its temper, and its thickness. The material shall also be free from corrosion and all contaminants, especially from the residues of the rolling and decoiling process.

In the case of job coaters, it is the responsibility of the coater's customer to provide material with adequate bending characteristics (unpainted material shall have the same mechanical properties that are requested from the painted material).

### A14 – 2 Test methods and requirements

The test methods described in this section are used to test finished products and organic coating materials for approval.

All test methods mentioned in Chapter 2 remain valid unless stipulated and/or modified in this appendix.

#### Substrate description for material that will be postformed:

- Approval of powder coatings suitable for postforming (A14 - 4.): for the mechanical tests stipulated in [Chapter 2 § 2.6](#) and in A14 - 2.7 and 2.8, the powder coating shall be applied with the maximum thickness indicated in the TDS on an aluminium test panel AA 5005 H24 0.81 mm thick (prepared with a chemical pretreatment). In case of uncertain results due to cracking of the aluminium support, a steel panel with a thickness of 0.51 mm will be used (Q-panel: QD type/ ISO 3574: Type CR1 steel test panel Type 3 ).
- For the in-house control of the mechanical tests stipulated in [Chapters 2 § 2.6](#), A14 - 2.7, and 2.8, mechanical tests shall be carried out on the production material (coils) or on Al samples obtained from the same raw Al material used for the production material (sheets).

**A14 - 2.1 Appearance**

See [Chapter 2, § 2.1](#).

**A14 - 2.2 Gloss**

See [Chapter 2, § 2.2](#).

**A14 - 2.3 Coating thickness****Sheets:**

See [Chapter 2, § 2.3](#).

**Coil coating:**

The coating thickness of the coils shall be measured at the beginning and end of the coil, at not less than three measuring areas (appr. 1 cm<sup>2</sup>), in the middle, and approximately 5 cm from each edge of the coil. If there are two or more colours in the same coil, the thickness of each colour shall be measured.

**A14 - 2.4 Adhesion**

See [Chapter 2, § 2.4](#).

**A14 - 2.5 Buchholz Indentation**

See [Chapter 2, § 2.5](#).

**A14 - 2.6 Cupping test (only for the approval of organic coatings)**

See [Chapter 2, § 2.6](#).

**A14 - 2.7 Bend test**

This test is specific for coated material that will be postformed and shall be conducted in place of the ISO 1519 bending test.

The bend test should be conducted according to EN 13523–7, including the alternative device described in EN 1396:2023\*, followed by a tape-pull adhesion test, as specified below:

- The test is performed in a longitudinal direction (rolling direction); if the transverse direction is used, it shall be specified in the inspection report. The bending radius is expressed as 'T' bend.
- Apply an adhesive tape (see [Chapter 2, § 2.4](#)) to the significant surface of the test panel following the mechanical deformation. Cover the area by pressing down firmly against the coating to eliminate voids or air pockets. Pull the tape off sharply at right angles to the plane of the panel after one minute.

**\* Bend test specific for postforming (according EN 1396:2023):**

As an alternative to the devices covered in EN 13523-7, the following method may be used to carry out the bending:

- The test piece (at least 250 mm x 30 mm) is bent (at 1 cm from one extremity) over an angle of approximately 100 ° by hand or any convenient means.
- The bent test piece is then pressed using a vice or a hydraulic press until the two faces come into contact. This constitutes the 'OT' bend.

- If the bent area shows cracks with apparent underlying metal, a second bend is carried out by folding the test piece over the first bend and then pressing it using a vice or press. This constitutes a ‘0,5T’ bend.
- This procedure is continued until a crack-free bend is obtained.
- The bends shall be examined using a 10x magnifying glass.
- The test shall be carried out at a temperature of  $23^{\circ}\text{C} \pm 2^{\circ}\text{C}$  and at a relative humidity of  $50\% \pm 5\%$ , 24 h after curing.

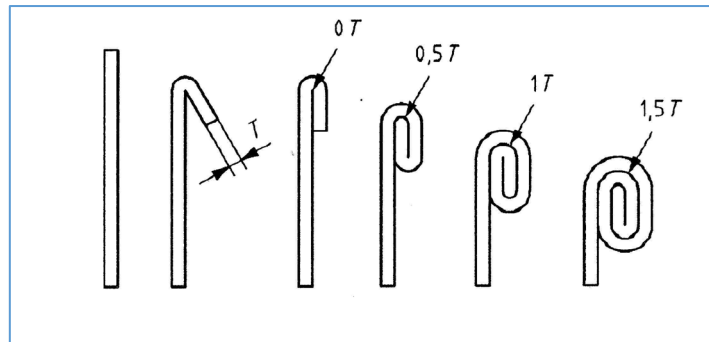

#### REQUIREMENTS FOR COATERS:

The limit values for the bend radii are governed by the choice of metal substrate (alloy, temper, and thickness) and coating material; therefore, the values shall be agreed-upon between the coater and customer according to the characteristics of the raw materials used (aluminium and powder paint) and stated in the order.

If the bending radius is not specified in the coater technical data sheet or agreed-upon between the coater and customer, the bending values shall not exceed 3T.

Using a 10x magnifying glass, the coating, bent with the specified bending radius, shall not show any sign of cracking and shall not show any sign of detachment following the tape-pull adhesion test.

NOTE: Material bending properties decrease as temperature decreases; the specified ‘T’ bend values are intended for a metal temperature which is not less than  $21^{\circ}\text{C}$  during processing.

#### REQUIREMENTS FOR POWDER SUPPLIERS:

The technical data sheet and label shall specify whether a powder coating is suitable for postforming. The technical data sheet of the product shall also contain the bending value ‘T’ with the related maximum allowed thickness of the coating (However not less than 60 microns); the permissible values are at a maximum of ‘1.5T’.

The substrate used for the test shall be specified.

### A14 - 2.8 Impact test

For coated material that will be post-formed, the test is carried out for in-house control by

- coaters: on production material
- powder manufacturers: on standard panels

The impact shall be carried out on the reverse side, whereas the results shall be assessed on the coated side.





Energy:

- Coaters: according to the coater technical data sheet or as per the written agreement between the coater and customer; not less than 5 Nm.
- Coating manufacturers: according to the technical data sheet, but not less than 5 Nm.

Apply an adhesive tape (see [Chapter 2, § 2.4](#)) to the significant surface of the test panel following the mechanical deformation. Cover the area by pressing down firmly against the organic coating to eliminate voids or air pockets. Pull the tape off sharply at right angles to the plane of the panel after one minute.

**REQUIREMENTS:**

Using normal corrected vision, the organic coating shall not show any sign of cracking or detachment.

The substrate used for the test shall be specified.

### **A14 - 2.9 Resistance to humid atmospheres containing sulphur dioxide**

See [Chapter 2, § 2.9](#).

### **A14 - 2.10 Acetic acid salt spray resistance<sup>27</sup>**

**For coatings applied on rolled material (sheets or coils):**

The test shall be conducted on three test pieces of the same rolled alloys used for production (for example AA 5005, AA 3105, and AA 3003).

In the case of coated material suitable for postforming, the samples shall be prepared in accordance with EN 13523-8.

For other requirements see [Chapter 2, § 2.10](#).

### **A14 - 2.11 Machu test**

**Accelerated corrosion test, on coated material:**

The test shall be carried out on pieces of coated rolled alloys from production (for example, AA 5005, AA 3105, and AA 3003).

For other requirements see [Chapter 2, § 2.11](#).

### **A14 - 2.12 Accelerated weathering test**

See [Chapter 2, § 2.12](#).

### **A14 - 2.13 Natural weathering test**

See [Chapter 2, § 2.13](#).

### **A14 - 2.14 Polymerisation test**

See [Chapter 2, § 2.14](#).

---

<sup>27</sup> Implementation only for data collection: the evaluation of the bent area will not have consequence on test results until 2025

**A14 - 2.15 Resistance to mortar**

See [Chapter 2, § 2.15](#).

**A14 - 2.16 Constant climate condensation water test**

See [Chapter 2, § 2.16](#).

**A14 - 2.17 Sawing, milling and drilling**

See [Chapter 2, § 2.17](#).

**A14 - 2.18 Filiform corrosion test**

**For coated material:**

The test shall be carried out on pieces of **coated rolled alloys** from production (for example, AA 5005, AA 3105, and AA 3003).

For other requirements see [Chapter 2, § 2.18](#).

**A14 – 2.19 Water spot test**

See [Chapter 2, § 2.9](#).

**A14 - 2.20 Scratch and mar resistance test (Martindale)**

See [Chapter 2, § 2.20](#).

**A14 – 3 Work specifications**

All the work specifications mentioned in Chapter 3 remain valid unless stipulated and/or modified in this appendix.

**A14 - 3.1 Storage of the products to be treated and layout of equipment**

See [Chapter 3, § 3.1](#).

**A14 - 3.2 Surface preparation**

Coil coating is performed in continuous lines (no jig or basket treatment).

**A14 - 3.2.1 Etching stage**

**For sheets**

See [Chapter 3, § 3.2.1](#).

**For coil coating**

The etching degree is measured by dipping a test sample (same material alloy as production material) in the etching tank solution for a defined time (equivalent to the real etching degree).

**a) Standard pre-treatment**

For coil coating lines, the total etching degree shall be at least 0,2 g/m<sup>2</sup>.

**b) Enhanced pretreatment (for SEASIDE endorsement)**

For coil coating, SEASIDE endorsement is not foreseen.

**A14 - 3.3 Chemical conversion coatings**

See [Chapter 3, § 3.3](#).

**A14 - 3.4 Anodic pretreatment (automatic SEASIDE endorsement)**

Anodic pretreatment, according to [Chapter 3 § 3.4](#), is not permissible. The anodic layer is currently cracking when applying bending procedures after the coating.

**A14 - 3.5 Electrophoretic coatings**

Not applicable.

**A14 - 3.6 Drying**

See [Chapter 3, § 3.6](#).

**A14 - 3.7 Coating and stoving****A14 -3.7.1 Coating**

For architectural applications, the coating plant installation shall use only organic coatings approved by QUALICOAT according to Chapter 4 'Approval of Organic Coatings'. For coated material suitable for postforming, it is necessary to use powder coatings **with a specific approval (PF-No.)**.

For other requirements see [Chapter 3, § 3.7.1](#).

**A14 - 3.7.2 Stoving**

See [Chapter 3, § 3.7.2](#).

**A14 - 3.8 Laboratory**

See [Chapter 3, § 3.8](#).

**A14 - 3.9 In-house control**

Coating plant installations holding the quality label shall monitor their production processes and inspect their finished products in accordance with A14 - 6.1 to A14 - 6.5.

**A14 - 3.10 Operating Instructions**

See [Chapter 3, § 3.10](#).

**A14 - 3.11 Registers**

See [Chapter 3, § 3.11](#).

**A14 - 4. Approvals of organic coatings**

All requirements for the approval of organic coatings mentioned in Chapter 4 remain valid unless stipulated and/or modified in this appendix.



Powder coatings suitable for postforming shall be granted a specific approval number (PF-No)<sup>28</sup>.

#### **Additional requirements for the approval of powder suitable for postforming:**

##### **Panels for mechanical tests**

The powder coating shall be applied with the maximum thickness indicated in the technical data sheet on standard test panels, having the characteristics described at the beginning of A14 - 2.

In any case, the test panels shall have at least the same mechanical properties that are requested for the powder coating.

The tests shall be made at the laboratory standard conditions (23°C ± 2°C) after a conditioning of at least 24h after curing.

##### ➤ **Bend test (Section A14 - 2.7)**

The powder coating shall be considered suitable for postforming if the coated panel can be folded without cracking using the bend test (A14 - 2.7) at a maximum value of 1.5T (the exact value shall be according to the value declared in the technical data sheet).

To limit the influence of the substrate, the test is conducted in the transverse direction.

##### ➤ **Impact test (Section A14 - 2.8)**

Energy:

5 Nm minimum (the exact value shall be according to the value declared in the technical data sheet); ISO 6272-2 / ASTM D 2794 (indenter diameter: 15.9 mm).

##### **Panels for the acetic salt spray test**

##### ➤ **Acetic salt spray test (A14 - 2.10)**

The panels used for the powder coatings approval shall be in AA 5005 H24 alloy, suitable for 1T bending, correctly pre-treated.

The samples shall be prepared in accordance with EN 13523-8 (for example, panels with a bent area).

## **A14 - 4.1 Granting of an approval**

### **A14 - 4.1.1 Technical information**

The technical data sheet and the label shall specify whether a powder coating is suitable for postforming. The technical data sheet of the product shall also contain:

- the bending value 'T' with the related maximum allowed thickness of the coating (not less than 60 microns).
- the permissible values are at a maximum of '1.5T'.

For powder coatings used in coil coating lines, it is necessary to specify in the technical data sheet: 'suitable for IR curing' and to provide the testing laboratories with the curing conditions simulating the IR curing in a standard oven.

---

<sup>28</sup> Approvals are currently valid only for Class 1.

**A14 - 4.1.2 Minimum laboratory equipment**

See [Chapter 4, § 4.1.2.](#)

**A14 - 4.1.3 Tests for granting of an approval**

See [Chapter 4, § 4.1.3.](#)

**A14 - 4.1.4 Basic colours to be tested for standard approvals and metallic extensions****A14 - 4.1.4.1 Standard approvals**

See [Chapter 4, § 4.1.4.1.](#)

**A14 - 4.1.4.2 Metallic extension**

See [Chapter 4, § 4.1.4.2.](#)

**A14 - 4.1.4.3 Approval for postforming**

If a manufacturer wishes to obtain approval for postforming, the following colours shall be tested:

- white RAL 9010.
- blue RAL 5010.
- red RAL 3005.

**A14 - 4.1.5 Basic colours to be tested for special approvals**

See [Chapter 4, § 4.1.5.](#)

**A14 - 4.1.6 Sampling**

See [Chapter 4, § 4.1.6.](#)

**A14 - 4.1.7 Assessment of test results**

See [Chapter 4, § 4.1.7.](#)

**A14 - 4.1.8 Inspection of coating manufacturer's plant**

See [Chapter 4, § 4.1.8.](#)

**A14 - 4.2 Renewal of an approval**

See [Chapter 4, § 4.2.](#)

**A14 - 4.2.1 Laboratory tests and Florida exposure****A14 - 4.2.1.1 Renewal of Class 1 and Class 1.5 approvals**

See [Chapter 4, § 4.2.1.1.](#)

**A14 - 4.2.1.2 Renewal of Class 2 and Class 3 approvals**

See [Chapter 4, § 4.2.1.2.](#)

**A14 - 4.2.1.3 Renewal of special approvals**

See [Chapter 4, § 4.2.1.3.](#)

**A14 - 4.2.1.4 Renewal of approvals for postforming**

Consistent quality of approved organic coating materials is monitored with all the tests listed in A14 - 4.1.3 being performed on two colours chosen from the three colours specified by QUALICOAT each year. The colours are chosen from RAL families<sup>29</sup> that do not contain critical colours.

The following families are considered as non-critical for the approval of powder coatings suitable for postforming: Class 1—1/A, 1/D, 3/C, 5/A,5/B,5/C, 5/D, 6/A, 6/B, 6/C, 6/D, 6/E, 7/A, 7/B, 7/C, 8/a, 8/B, 8/C, 9/A, 9/B, and 9/C.

**A14 - 4.2.2 Sampling**

See [Chapter 4, § 4.2.2.](#)

**A14 - 4.2.3 Assessment of laboratory test results**

See [Chapter 4, § 4.2.3.](#)

**A14 - 4.2.4 Assessment of the Florida test results**

See [Chapter 4, § 4.2.4.](#)

**A14 - 4.2.5 Banned colours**

See [Chapter 4, § 4.2.5.](#)

**A14 - 4.2.6 Suspended colours**

See [Chapter 4, § 4.2.6.](#)

**A14 - 4.2.7 Withdrawal of an approval or extension**

See [Chapter 4, § 4.2.7.](#)

**A-14 - 4.3 Powder manufacturer's right of appeal**

See [Chapter 4, § 4.3.](#)

**A-14 - 4.4 Use of the logo by coating manufacturers**

See [Chapter 4, § 4.4.](#)

**A14 – 5 Licensing of Coaters' production sites**

All the requirements mentioned in Chapter 5 for the licencing of coaters remain valid unless stipulated and/or modified in this appendix.

**A14 - 5.1 Granting of a licence (quality label)**

See [Chapter 5, § 5.1.](#)

---

<sup>29</sup> See Appendix A11

**A14 - 5.1.1 Verification of the data concerning the coating lines**

See [Chapter 5, § 5.1.1.](#)

**A14 - 5.1.2 Inspection of materials**

See [Chapter 5, § 5.1.2.](#)

The inspector will check that for outside architectural applications the licensee uses organic coating materials approved by QUALICOAT for postforming according to § A14.4.

**A14 - 5.1.3 Inspection of laboratory equipment**

See [Chapter 5, § 5.1.3.](#)

**A14 - 5.1.4 Inspection of production process and equipment**

See [Chapter 5, § 5.1.4.](#)

**A14 - 5.1.5 Inspection of chemical pretreatment**

See [Chapter 5, § 5.1.5.](#)

**A14 - 5.1.6 Inspection of finished products****Thickness measurements of sheets**

See [Chapter 5, § 5.1.6.](#)

**Thickness measurements of coils**

See A14 - 2.3.

A total of 150 measurements shall be made.

**A14 - 5.1.7 Inspection of the test panels (made of the same material as the finished product)**

If the material is intended to be postformed, the inspector shall perform the following tests on the finished products:

- Appearance -to test production uniformity ([Chapter 2, § 2.1](#))
- Thickness ([Chapter 2, § 2.3](#) and A14 - 2.3)
- Gloss ([Chapter 2, § 2.2](#))
- Dry adhesion ([Chapter 2, § 2.4.1](#)) and wet adhesion ([Chapter 2, § 2.4.2](#))
- Bend (A14 - 2.7)
- Impact (A14 - 2.8)
- Acetic acid salt spray ([Chapter 2, § 2.10](#) and A14 - 2.10)
- Machu ([Chapter 2, § 2.11](#) and A14 - 2.11)
- Polymerisation ([Chapter 2, § 2.14](#))
- Sawing ([Chapter 2, § 2.17](#))

If mechanical and destructive tests cannot be performed on production material, they shall be conducted on test panels obtained using the same raw material as substrate of the finished products and processed together with the production material.

**A14 - 5.1.8 Review of in-house control and registers**

See [Chapter 5, § 5.1.8.](#)

**A14 - 5.1.9 Final assessment for granting the licence**

See [Chapter 5, § 5.1.9.](#)

**A14 - 5.1.10 SEASIDE endorsement**

For sheets: see [Chapter 5, § 5.1.10.](#)

For coil coating: not foreseen.

**A14 - 5.1.11 'Postforming' endorsement**

If a coater has applied for the postforming endorsement, an inspection shall be conducted following the guidelines set out in the QUALICOAT Specifications and in this appendix.

For coil coating, or in the case of lines used exclusively for coating material for postforming, the postforming endorsement is mandatory, and each inspection visit shall include the controls as described in this appendix. The endorsement shall be granted after two inspection visits, made for granting the licence and the postforming endorsement, have been satisfactory.

In the case of piece coating (no coil coating), one inspection shall be satisfactory before an endorsement is granted. If the results of the inspection meet the requirements, the postforming endorsement shall be granted.

A specific certificate shall be issued stating that the coating plant installation is able to produce finished products that meet the postforming requirements.

If the results of the inspection do not meet the requirements, the coating applicator shall wait at least three months before making a new application for a postforming endorsement.

**A14 - 5.2 Routine inspections of licensees****Licences with 'Postforming' endorsement**

Routine postforming inspections shall be conducted as set out in this appendix during QUALICOAT inspections.

In case of coil coating, the endorsement shall be renewed if the results of at least two postforming inspections per year meet the requirements.

In case of piece coating (no coil coating), the endorsement shall be renewed if the results of at least one postforming inspection per year meet the requirements.

For plants with mixed production (standard and postforming) the coating thickness measurements and corrosion tests shall be carried out on both types of material.

If the results of the inspection meet the requirements, the postforming endorsement shall be confirmed. If the results do not meet the requirements, another inspection shall be made within one month.

If no postforming inspection is possible during QUALICOAT visits, an additional announced inspection shall be carried out.





If the additional inspection produces unsatisfactory results, the postforming endorsement shall be withdrawn immediately. The coating applicator shall wait at least three months before making a new application for a 'Postforming' endorsement.

### **A14 - 5.3 Licensee's right of appeal**

See [Chapter 5, § 5.3](#).

### **A14 - 5.4 Confidentiality of information**

See [Chapter 5, § 5.4](#).

### **A14 - 5.5 Deadline for submission of inspection reports**

See [Chapter 5, § 5.5](#).

### **A14 - 5.6 Use of the logo by Licensees**

See [Chapter 5, § 5.6](#).

## **A14 – 6 Specifications for in-house control**

All in-house control requirements mentioned in Chapter 6 remain valid unless stipulated and/or modified in this appendix.

The mechanical tests shall be conducted on the production material (coils) or Al samples obtained from the same raw Al used for the production material (sheets).

### **A14 - 6.1 Controlling the production process parameters**

#### **A14 - 6.1.1 Chemical pretreatment baths**

See [Chapter 6, § 6.1](#).

#### **A14 - 6.1.2 Water quality**

See [Chapter 6, § 6.1.2](#).

#### **A14 - 6.1.3 Measuring the temperature of chemical pretreatment and rinsing baths**

See [Chapter 6, § 6.1.3](#).

#### **A14 - 6.1.4 Recording and measuring the drying temperature**

See [Chapter 6, § 6.1.4](#).

#### **A14 - 6.1.5 Measuring the stoving conditions**

For sheets: see [Chapter 6, § 6.1.5](#).

For **coil coating**: the plant shall be equipped with at least one permanent noncontact device for reading the PMT (Peak Metal Temperature). The displayed temperature shall be recorded at least once every two hours. An additional stoving curve is not necessary.



## **A14 - 6.2 Quality control of the chemical pretreatment**

### **A14 - 6.2.1 Testing the etching degree**

For sheets: see [Chapter 6, § 6.2.1](#).

For coils: see [Chapter 6, § 6.2.1](#) and A14 - 3.2.1.

### **A14 - 6.2.2 Testing the weight of the conversion coating**

See [Chapter 6, § 6.2.2](#).

## **A14 - 6.3 Quality control of the finished products**

### **A14 - 6.3.1 Gloss test (ISO 2813)**

See [Chapter 6, § 6.3.1](#).

### **A14 - 6.3.2 Coating thickness test (ISO 2360)**

For sheets: see [Chapter 6, § 6.3.2](#).

For **coil coating**: the coating thickness shall be measured as described in A14 - 2.3. At least 15 measurements per coil shall be made.

### **A14 - 6.3.3 Appearance test**

See [Chapter 6, § 6.3.3](#).

### **A14 - 6.3.4 Adhesion test**

#### **A14 - 6.3.4.1 Dry adhesion (ISO 2409)**

See [Chapter 6, § 6.3.4.1](#).

The test is performed on production material (coils) or on test panels made with the same production material and processed together with the production lot (sheets).

#### **A14 - 6.3.4.2 Wet adhesion**

See [Chapter 6, § 6.3.4.2](#).

### **A14 - 6.3.5 Polymerisation test**

See [Chapter 6, § 6.3.5](#).

### **A14 - 6.3.6 Bend test (A-14 - 2.2)**

The test is performed on production material (coils) or on test panels made with the same production material and processed together with the production lot (sheets).

### **A14 - 6.3.7 Impact test (A-14 - 2.3)**

The test is performed on production material (coils) or on test panels made with the same production material and processed together with the production lot (sheets).



**A14 - 6.4 Quality control registers**

**A14 - 6.4.1 Control register for the production process**

See [Chapter 6, § 6.4.1.](#)

**A14 - 6.4.2 Control register for test panels**

See [Chapter 6, § 6.4.2.](#)

**A14 - 6.4.3 Control register for finished products**

See [Chapter 6, § 6.4.3.](#)

**A14 - 6.4.4 Control register for tests carried out by the chemical manufacturer**

See [Chapter 6, § 6.4.4.](#)

**A14 - 6.5 Table summarizing the Specifications for In-House Control in case of Postforming**

CONTROL	OBJECT TESTED		FREQUENCY
<b>Process</b> (A14 - 6.1)	Chemical pretreatment baths, degreasing, pickling, chromating, rinsing	Chemical Parameters	Once per bath in every working shift, or according to the chemical supplier's advice, that shall be at least once per day (24 hours).
	Conductivity of the water		Once per bath in every working shift, or according to the chemical supplier's advice, that shall be at least once per day (24 hours).
	Temperature of chemical pretreatment		Once per bath in every working shift, or according to the chemical supplier's advice, that shall be at least once per day (24 hours).
	Drying temperature		<ul style="list-style-type: none"> <li>Once in every working shift: record the displayed temperature</li> <li>Once a week: make one recording of the temperature using strips or some other means</li> </ul>
	Stoving conditions		Sheets: <ul style="list-style-type: none"> <li>Once in every working shift: record the displayed temperature</li> <li>Twice a week: make 1 stoving curve on profiles</li> </ul> Coil coating: <ul style="list-style-type: none"> <li>Every 2 hours record the displayed temperature (continuous monitoring of PMT)</li> </ul>
<b>Conversion coating</b> (A14 - 6.2)	Etching degree		Once in every working shift, or according to the chemical supplier's advice, that shall be at least once per day (24 hours).
	Weight of the conversion coating (chromate conversion)		Once in every working shift, or according to the chemical supplier's advice, that shall be at least once per day (24 hours).
	Weight of the conversion coating (chromium-free)		Once in every working shift, or according to the chemical supplier's advice, that shall be at least once per day (24 hours).
<b>Finished products</b> (A14 - 6.3)	Gloss		Once in every working shift for each shade and manufacturer. Coil coating: the gloss shall be measured at the beginning and at the end of each coil and of each colour
	Coating thickness		According to the order lot size; for coil coating: the thickness shall be measured at the beginning and at the end of each coil and of each colour.;



CONTROL	OBJECT TESTED	FREQUENCY
	Appearance	According to the order lot size; Coil coating: the appearance evaluation and the colour measurement shall be made at the beginning and at the end of each coil and of each colour.
	Wet adhesion	Once in every working shift <i>All samples from one day may be tested together.</i>
<b>(Panels of finished products (A14 - 6.3))</b>	Dry adhesion	Minimum of 1 x sample* for every two production hours. Once for each coil and each colour
	Polymerisation (optional for powder coatings)	Once in every working shift for each colour shade and gloss category and for each manufacturer. Once for each coil and each colour
	Bend test	Minimum of 1 x sample* for every two production hours. Once for each coil and each colour
	Impact test	Minimum of 1 x sample* for every two production hours. Once for each coil and each colour



## A15 – Specifications for off-site anodisers

The anodising plant shall have a PRE-OX licence granted by QUALICOAT, according to [Section 3 of this appendix](#).

Licensed coaters using off-site anodic pretreatment shall have a SEASIDE (PRE-OX) endorsement granted by QUALICOAT, according to Section § [5.1.11](#) of the Specifications.

### 1. Work specifications for off-site anodisers

The following minimum requirements shall be met by the off-site anodiser:

#### 1.1. Surface Preparation

The aluminium surface shall be treated to eliminate all impurities that could pose problems in the anodic pretreatment.

#### 1.2. Etching

The aluminium parts (extrusions and sheet, not cast) shall be etched with a minimum etching rate of 2 g/m<sup>2</sup>. In the case of alkaline etching, desmutting shall be necessary.

#### 1.3. Thickness of the pre-anodised layer

The anodic pretreatment shall be chosen to produce an anodic coating with a thickness of at least 4 µm (not more than 10 µm) without powdering or surface flaws.

The anodic pretreatment parameters can be as follows:

- Acid concentration (sulphuric acid): 180–220 g/l.
- Aluminium content: 5–15 g/l.
- Temperature: 20–30°C (± 1°C of the temperature chosen by the anodiser).
- Current density: 0.8–2.0 A/dm<sup>2</sup>.
- Agitation of the electrolyte.

#### 1.4. Post-treatment and Rinsing after Pre-anodising

After anodic pretreatment, the aluminium shall be rinsed for such a time and at such a temperature as is required to remove the acid from the pores and to fulfil the requirements of the wet adhesion test.

Enhancing rinsing with a hot sealing step and/or a passivation step with a QUALICOAT approved chemical pretreatment system or chromate conversion coating is permitted. The rinsing process shall not produce a sealed surface, as this increases the risk of adhesion failure. No-rinse passivation is not permitted when a period of 16 hours has passed.

The conductivity of the dripping water of the final rinse prior to coating shall not exceed a maximum of 30 µS/cm at 20°C. The final rinse prior to the coating shall be performed in either the anodising or coating line. The conductivity of the dripping water should only be measured for open sections and not for hollow sections.

In the event that it is not possible to measure the conductivity of the dripping water for immersion installation, the conductivity of the rinse water in the tank shall be measured with a maximum conductivity of 15 µS/cm at 20°C before immersion starts.

Sealing additives can decrease the quality of the final product. It is the responsibility of the anodiser and the coater to verify the compatibility with the coating process.



### 1.5. Storage conditions

Pre-anodised aluminium shall never be stored or transported in an atmosphere that is dusty, damp (condensation or similar), or detrimental to it. Good atmospheric and dry conditions shall always be maintained in storage areas during transportation. All workers handling pre-anodised aluminium shall wear clean textile gloves to avoid surface contamination.

### 1.6. Storage time and transportation

Pre-anodised parts shall not be stored for more than 16 hours. However, the parts may be stored (including transportation, where applicable) for up to 72 hours, provided that additional rinsing has occurred with demineralised water with a conductivity of maximum 30  $\mu\text{S}/\text{cm}$  at 20°C and drying has taken place prior to coating (no etching allowed). The risk of insufficient adhesion increases the longer the parts are stored.

### 1.7. Mandatory minimum equipment

The anodiser's laboratory shall have the apparatus and chemicals necessary for testing and controlling the process solutions and finished products. The laboratory shall at least be equipped with the following apparatus and equipment:

- Conductivity meter.
- pH-meter.
- Thickness meter.
- Calibration tools for the tests stipulated.

Each piece of apparatus shall have a data sheet showing the apparatus identification number and calibration records.

### 1.8. Recording of anodising bath test results

The anodising plant shall perform and record the following additional tests when processing anodic pretreatment:

- The acid concentration and aluminium content of the anodising bath shall be analysed once daily.
- The temperature of the anodising bath shall be checked every 8 hours.
- The etching rate shall be checked once per day.
- The thickness of the anodic coating shall be checked (every load).

## 2. Cooperation between external anodiser and coater

External anodisers and coaters shall cooperate closely.

The test results from the external anodiser shall be delivered to the coater with a delivery note, and the following information shall be included where applicable (i.e., if it was not already described in the general agreement between the external anodiser and the coater):

- Qualanod licence number or quality management system certificate number.
- Description of all pre-anodising process steps (type of surface treatment, chemical composition, temperature, and treatment time).
- Detailed description of rinsing conditions (30  $\mu\text{S}$ ), including information about the usage and the type of hot sealing or approved passivation, including parameters, values, and limits.
- Production date and time.
- Number of test panels that are produced in the same lot together with the material.



- Alloy.
- Etching requirements of cast material.
- Location of jiggging marks.

For each delivery, the anodiser shall gather the following records from the coater:

- Name and licence number of the coater.
- Date of anodizing.
- Date of coating.
- Order number.
- Rinsing water conductivity.
- P-No and colour.
- Results of the wet adhesion test.

This information shall be readily available to the inspector.

### **3. Licensing of off-site anodisers**

The anodising plant shall have a QUALANOD licence or be certified by an accreditation body with a Quality Management System.

#### **3.1. Granting of a PRE-OX licence to an anodiser**

One inspection shall be satisfactory for a PRE-OX licence to be granted to an anodiser. This inspection will be made by appointment at the anodiser's request.

##### **3.1.1. Inspection**

The inspectors shall take along the following equipment:

- Conductivity meter.
- Thickness meter.
- Calibration tools for the tests stipulated.

The inspector shall check the following using the inspection form approved by QUALICOAT:

- Inspection of laboratory equipment.
- Delivery appointments.
- In-house control.
- Records for every delivery.

##### **3.1.2. Final assessment for granting the PRE-OX licence**

The inspector submits the inspection report to the General Licensee for the evaluation.

Under the supervision of QUALICOAT, the General Licensee must adhere to the following procedure:

- If the results of the inspection meet the requirements, the PRE-OX licence shall be granted. A specific QUALICOAT PRE-OX certificate shall be issued stating that the anodising plant installation can produce finished products that meet the QUALICOAT PRE-OX requirements.
- If the results of the inspection do not meet the requirements, the anodiser shall wait at least three months before making a new application for a PRE-OX licence.

#### **3.2. Licence renewal**

After an anodising plant is granted a PRE-OX licence, it shall be inspected once a year.



Routine inspections shall be conducted without prior notice. Inspectors will only be authorised by the GL or QUALICOAT Secretariat to announce an inspection in the case of travel safety issues or visa problems.

### **3.2.1. Inspection**

The inspectors shall take along the following equipment:

- Conductivity meter.
- Thickness meter.
- Calibration tools for the tests stipulated.

The inspector shall check the following using the inspection form approved by QUALICOAT:

#### **Review of in-house control and registers**

The inspector shall check that in-house control has been carried out in accordance with section § 1. above and that the anodiser maintains close cooperation with the coater as described in section § 2 above.

### **3.2.2. Final assessment for renewing the licence**

Under the supervision of QUALICOAT, the General Licensee must adhere to the following procedure:

- If the inspection results meet the requirements, authorisation to use the quality label will continue.
- If the results of the inspection do not meet the requirements, another inspection shall be conducted within one month (allowing for holiday periods) after the anodiser has received a notification of an unsatisfactory inspection from the General Licensee and/or QUALICOAT. In the meantime, the licensee shall rectify the non-conformities and immediately inform the General Licensee or QUALICOAT.
- If the repeat inspection produces unsatisfactory results, the PRE-OX licence will be withdrawn immediately. The anodiser shall wait for at least three months before making a new application for a licence to use the quality label.

### **3.3. Anodisers' right of appeal**

The anodising plant shall receive a copy of each inspection report. If the results do not meet the requirements, full details and reasons shall be given. The plant shall be entitled to appeal within 10 days.

### **3.4. Confidentiality of information**

All information concerning the inspection results and their assessment shall be confidential.

### **3.5. Deadlines for submission of inspection reports**

All inspection reports (including test results) shall reach QUALICOAT's Secretariat within three months of the dates of the inspections.





### 3.6. Use of the logo by PRE-OX anodisers



Licence PRE-OX ANODISER  
n° xxxx

The logo may be used on the products themselves, business stationery, quotations or invoices, price lists, cards, display boxes, on all company literature, brochures, catalogues and newspaper advertisements.

By applying the logo to a product, the anodiser guarantees that the quality of the finished product supplied to QCT licenced coaters meets all the requirements of the Specifications.

Whenever an anodiser mentions or references to QUALICOAT, it shall systematically indicate its licence number. This shall apply to both the use of the logo and in texts.